



italveneta
didattica
a better play

www.italvenetadidattica.com



Giocare per imparare, giocare per divertirsi,
giocare per sviluppare la creatività e crescere.
Ma soprattutto, giocare in sicurezza.

*Playing to learn, playing to have fun,
playing to become more creative and grow
but, above all, playing safely.*

a better play





Oltre trent'anni di esperienza, di competenza nei materiali e nelle tecnologie, di creatività nello sviluppo dei prodotti, fanno di Italveneta Didattica l'interlocutore migliore per asili e scuole nella scelta dei materiali didattici.

Over thirty years' experience, skilled use of materials and technologies, and creativeness when developing products make Italveneta Didattica the very best choice if you are buying teaching materials for nurseries and schools.





Una gamma di prodotti che spazia dai giochi di gruppo a quelli matematici, dai supporti per l'attività motoria all'arredamento.

Our range includes team toys, teaching aids, motor skills kits and furniture.





Garanzia di conformità alle più severe certificazioni internazionali in materia di sicurezza; qualità del prodotto, che è made in Italy al 100%; sensibilità alle esigenze del mondo della scuola che nasce dall'esperienza e da una grande passione.

We guarantee compliance with the stricter international safety certifications;

100% Made in Italy quality;

awareness about the requirements of schools, coming from our long experience and great passion.

La gioia e la sicurezza dei bambini sono troppo importanti, e in questo settore l'affidabilità non si improvvisa.

The joy and safety of kids are extremely important, and reliability in this sector cannot be improvised.



PERCHÈ SONO IMPORTANTI LE CERTIFICAZIONI?

I bambini attraverso il gioco imparano a conoscere il mondo e a stare con gli altri. È fondamentale che i giochi con cui i bimbi passano le loro giornate a casa, all'asilo o a scuola siano sicuri e non causino loro incidenti.

I giochi Italveneta Didattica sono sicuri al 100% in quanto hanno superato severi test da parte di enti certificatori internazionali che ne attestano la totale sicurezza a garanzia di un prodotto sempre affidabile.

NUOVA Direttiva 2009_48_CE Sicurezza giocattoli

Direttiva che stabilisce le nuove norme sulla sicurezza dei giocattoli e sulla loro libera circolazione nella Comunità Europea. Si applica ai prodotti progettati o destinati, in modo esclusivo o meno, a essere utilizzati per fini di gioco da bambini di età inferiore a 14 anni («giocattoli»).

La direttiva specifica gli obblighi di tutti gli operatori della catena di fornitura dei giocattoli (fabbricanti, importatori e distributori) definendone le responsabilità.

La direttiva specifica le caratteristiche della marcatura CE, mediante la quale il fabbricante indica che il giocattolo è conforme ai requisiti applicabili stabiliti da tutta la normativa comunitaria. La nuova direttiva introduce sostanziali ed importanti nuovi adempimenti in materia di avvertenze e marcature di legge.

UNI EN 71-1

I TEST previsti da questa norma prendono in esame i requisiti generali, materiali, bordature, punte e fili metallici, punte acuminate, imballi, avvertimenti e istruzioni per l'uso, marchio CE, età di utilizzo.

La norma specifica i requisiti e i metodi di prova per le proprietà meccaniche e fisiche dei giocattoli. La norma si riferisce a giocattoli nuovi e tiene conto della durata di utilizzo normale e prevedibile nonché delle condizioni normali o prevedibili di uso dei giocattoli, considerando il comportamento abituale dei bambini.

UNI EN 71-2

I TEST verificano che il prodotto non contenga materiale infiammabile. La norma specifica le categorie di materiali infiammabili proibiti per tutti i giocattoli e i requisiti relativi all'infiammabilità di alcuni giocattoli quando sono esposti ad una modesta sorgente di fiamma.

UNI EN 71-3

I TEST verificano le proprietà chimiche del prodotto.

La norma specifica i requisiti e i metodi di prova per la migrazione di determinati elementi (antimonio, arsenico, bario, cadmio, cromo, piombo, mercurio e selenio) dai materiali che costituiscono giocattoli e da parti di giocattoli ad eccezione dei materiali non accessibili.

UNI EN 71-8

I TEST verificano le disposizioni generali di sicurezza di altalene, scivoli e giocattoli di attività simili per interno ed esterno. La norma specifica i requisiti e i metodi di prova per i giochi di attività.

UNI EN 71-9

La norma specifica i requisiti per la migrazione o il contenuto di alcuni composti chimici organici pericolosi.

UNI EN 1176-1 e 1176-3

I TEST verificano i requisiti generali ed aggiuntivi di sicurezza e metodi di prova delle attrezzature per aree da gioco.

UNI EN 1729-1 e 1729-2 UNI EN 1730-6.3/6.5/6.6/6.7

I test effettuati verificano, ad es., il carico statico verticale, la fatica verticale, l'urto verticale, la stabilità con carico verticale. La norma specifica le dimensioni funzionali, i requisiti di sicurezza e i metodi di prova per mobili, sedie e tavoli per istituzioni scolastiche.

WHY ARE CERTIFICATIONS IMPORTANT?

NEW Directive 2009_48_CE

Safety of toys

This directive lays down new rules on the safety of toys and on their free movement in the European Community. It applies to products designed or intended, whether or not exclusively, for use in play by children under 14 years of age («toys»).

The directive specifies the obligations of all economic operators in the toy supply chain (manufacturers, importers and distributors) defining their responsibilities.

The directive specifies the characteristics of the CE marking, by which the manufacturer indicates that the toy is in conformity with the applicable requirements set out in the entire European standard. The new directive introduces substantial and important new obligations regarding warnings and legal markings.

UNI EN 71-1

The TESTS in this standard examine the general requirements, materials, edges, points and metallic wires, sharp points, packaging, warnings and instructions for use, CE marking, age of use.

The standard specifies the requirements and test methods for the mechanical and physical properties of toys. It refers to new toys, taking into account the period of foreseeable and normal use, and that the toys are used as intended or in a foreseeable way, bearing in mind the normal behaviour of children.

UNI EN 71-2

The TESTS check that the product does not contain flammable material.

The standard specifies the categories of flammable materials which are prohibited in all toys and the requirements concerning the flammability of certain toys when they are submitted to a small source of ignition.

UNI EN 71-3

The TESTS check the chemical properties of the product.

The standard specifies the requirements and test methods for the migration of certain elements (antimony, arsenic, barium, cadmium, chromium, lead, mercury and selenium) from toy materials and from parts of toys, with the exception of inaccessible materials.

UNI EN 71-8

The TESTS check the general safety provisions of swings, slides and similar activity toys for indoor and outdoor use. The standard specifies the requirements and test methods for activity toys.

Children learn to experience the world and interact with others by playing.

It is fundamental that toys used by children at home as well as at school are safe and do not cause accidents.

Italveneta toys are 100% safe because they have passed International Institutes for Certifications stricter tests.

UNI EN 71-9

The standard specifies the requirements for the migration or content of certain hazardous organic chemical compounds.

UNI EN 1176-1 and 1176-3

The TESTS check the general and additional safety requirements and test methods of playground equipment.

UNI EN 1729-1 and 1729-2 UNI EN 1730-6.3/6.5/6.6/6.7

The TESTS carried out check, for example, vertical static load, vertical fatigue, vertical impact, stability under vertical load.

The standard specifies the functional dimensions, safety requirements and test methods for furniture, chairs and tables for educational institutions.





ARREDAMENTO
page 10
FURNITURE



ATTIVITÀ MOTORIA
page 20
ACTIVE PLAY



ATTIVITÀ RICREATIVA
page 42
RECREATIONAL ACTIVITIES



SUSSIDI DIDATTICI
page 56
TEACHING AIDS



GRANDI GIOCHI
page 60
PLAYGROUND TOYS



a **better play**

ARREDAMENTO



FURNITURE

SEDIA BREVETTATA PATENTED CHAIR

Conforme / in compliance with
UNI EN 1729-1/2

art. 013 art. 014

SEGGIOLINA IN PLASTICA NIDO

(tappo h. 2 cm)

PLASTIC KINDERGARTEN CHAIR

(2 cm high cap)

SEGGIOLINA IN PLASTICA MATERNA

(tappo h. 5 cm)

PLASTIC PRESCHOOL CHAIR

(5 cm high cap)

La seggiolina si presenta di facile adattamento ai vari ambienti grazie alla sua forma armoniosa. È realizzata in materiale plastico atossico, resistente, di prima scelta che ne garantisce la perfetta stabilità e solidità.

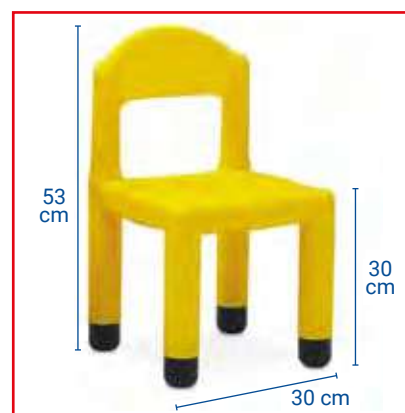

Our chair is suitable for any environment thanks to its shape. It is made of high quality, non-toxic, strong plastic, that guarantees 100% stability and sturdiness.

I particolari sono stati studiati al fine di renderla sicura e confortevole, inoltre la sua forma sagomata ed esclusiva favorisce una corretta seduta antiscivolo.

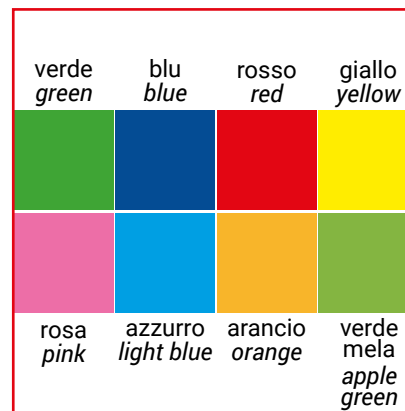

The details of this chair have been designed to make it safe and comfortable. Its shape enables children to sit properly without slipping.

L'altezza della sedia può essere modificata con una semplice sostituzione dei tappi inferiori (da 2 cm e 5 cm).

The height of the chair can be adjusted by changing the caps at the bottom of the legs (2 cm and 5 cm high).

TAVOLI BREVETTATI PATENTED TABLES

Conforme / in compliance with
UNI EN 1730-6.3/6.5/6.6/6.7



Tavolo realizzato con una particolare struttura avente il piano bianco in conglomerato fibrolegnoso idrofugo nobilitato, antiriflesso e antigraffio. Bordato perimetralmente con Esaflex morbido, antiurto di colore rosso, profilo e spigoli arrotondati.

Le gambe, prodotte in polipropilene, si assemblano al piano con 4 raccordi angolari che rendono il tavolo solido e resistente a qualsiasi tipo di pressione esercitata.

**TECNOLOGIA DI
ASSEMBLAGGIO GARANTITA**

**GUARANTEED ASSEMBLY
TECHNOLOGY**

Our tables have a special structure with a white top in veneered waterproof fibreboard which is non-reflecting and scratch-proof. The edge is trimmed all round with soft, red, shockproof Esaflex and the corners are rounded.

The polypropylene legs are assembled to the top by 4 corner fittings which make the table resistant to any type of pressure.

**ANGOLARE
TAVOLO BREVETTATO**

**PATENTED
TABLE CORNERS**



TAVOLI BREVETTATI
PATENTED TABLES

Conforme / in compliance with
UNI EN 1730-6.3/6.5/6.6/6.7

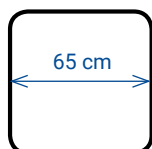
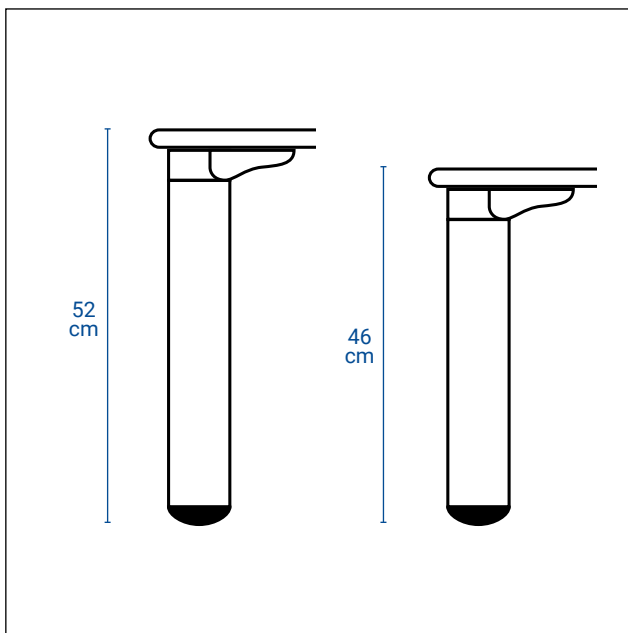

art. 015 TAVOLO QUADRATO 65x65 cm
SQUARE TABLE 65x65 cm

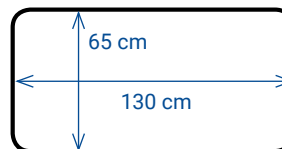

art. 016 TAVOLO RETTANGOLARE 130x65 cm
RECTANGULAR TABLE 130x65 cm

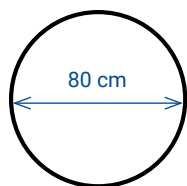

art. 017 TAVOLO CIRCOLARE Ø 80 cm
ROUND TABLE Ø 80 cm

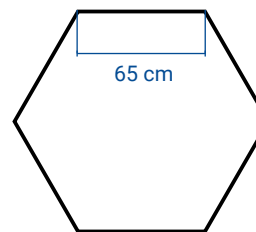

art. 018 TAVOLO ESAGONALE lato 65 cm
HEXAGONAL TABLE each side 65 cm

NEW

BRANDINE COTS

Conforme / in compliance with
EN 71-1/2/3 

art. 138 BRANDINA MONTATA art. 138 ASSEMBLED COT

Dimensioni: 134x54x14 cm Sizes: 134x54x14 cm

art. 139 BRANDINA SMONTATA art. 139 DISASSEMBLED COT

La nuova brandina è resistente e confortevole affinché il riposo del bambino sia sicuro.

The new cot is sturdy and comfortable to make children's rest safe.

La tela è realizzata in tessuto atossico, di colore azzurro, facilmente lavabile. La brandina è disponibile nelle due versioni montata e smontata, di facile montaggio.

The non-toxic, light blue fabric is easy to wash. It can be ordered either assembled or dismantled as it is easy to assemble.



BRANDINE ASILO NIDO E MATERNA KINDERGARTEN AND PRESCHOOL COTS

Caratteristiche principali: *Main features:*

- leggera, impilabile e trasportabile. • *light, stackable and transportable.*
- tessuto robusto e confortevole • *strong, comfortable fabric*
- struttura con tubi ovali in alluminio antiruggine • *oval, aluminium, anti-rust tubes*
- tessuto lavabile, traspirante e ignifugo • *washable, transpirable and fireproof fabric*
- cuciture termosaldate che prevengono la rottura • *heat-sealed seams to avoid threads*
- struttura in un unico pezzo, senza viti • *single structure with no spare screw*
- angoli smussati • *rounded corners*



**italveneta
didattica**
a better play

www.italvenetadidattica.com

RECINZIONE FENCE

Conforme / in compliance with
UNI EN 1176-1



art. 200 PLAY PEN

1 kit include
4 pannelli (110x5x60h)
e 4 basi.
Lunghezza totale 4,40 m

*1 kit includes
4 panels (110x5x60h)
and 4 bases.
Total length 4.40 m*



Struttura modulare ideale per creare spazi gioco completamente chiusi o per delimitare aree.

Utilizzo interno ed esterno.

Realizzati con materiale di alta qualità e atossico, i pannelli hanno forme arrotondate, e grazie al perfetto e semplice incastro, se posizionati in linea restano perfettamente fermi e fissi al piano senza l'utilizzo di un ancoraggio. Struttura stabile e solida, disponibile in vari colori.

Modular structure ideal to create or delimitate play areas. **Suitable both in and outdoor.**

The panels are produced with high quality, nontoxic material. They are rounded, easy to assemble and self-standing when assembled in a straight line. Available in different colours.

verde green blu blue viola violet giallo yellow fucsia fuchsia azzurro light blue arancio orange bianco white verde mela apple green



italveneta
didattica
a better play

www.italvenetadidattica.com

NEW

TAPPETI FLOORING

Conforme / in compliance with
EN 71-1/2/3 + A2 EN 1177 

art. 190

TAPPETO EVA cm 50x50 - Spessore 10 mm
EVA FLOORING 50x50 cm - Thickness 10 mm

art. 191

TAPPETO EVA cm 100x100 - Spessore 10 mm
EVA FLOORING 100x100 cm - Thickness 10 mm

Il nuovo tappeto antitrauma è una protezione ideale per aree gioco interne. La struttura ad incastro è semplice da installare, non richiede alcun tipo di collante e si può pulire con un panno umido e del detergente neutro. Completo di bordo perimetrale e angoli. Disponibile in 5 colori: arancio, blu, giallo, rosso e verde.

Le principali caratteristiche del Materiale EVA (Etilene Vinil Acetato) sono:

- Atossico
- Ignifugo
- Idrorepellente
- Antimuffa e antibatterico
- Fonoassorbente

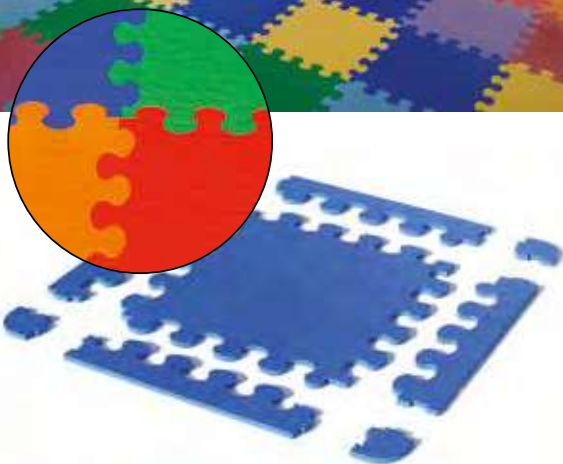

The new anti-shock flooring is the perfect protection for indoor playground areas. Its interlocking structure is easy to assemble, does not require any adhesive and can be cleaned by a wet cloth and neutral detergent. Provided with perimeter edge and corners. Available in 5 colours: orange, blue, yellow, red and green.

The main features of the EVA (Ethylene-Vinyl Acetate) material are:

- Non toxic
- Fire-resistant
- Waterproof
- Anti-mould and anti-bacterial
- Sound absorbing



blu / blue



giallo / yellow



fucsia / fuchsia



arancio / orange



verde mela / apple green

**italveneta
didattica**
a better play

www.italvenetadidattica.com

NEW

COPRITERMO RADIATOR COVER

Conforme / in compliance with
UNI 9177- 8457 - 9174 – 1088 sez. 3.3 – 1907 **CE**

art. 196

COPRITERMO / RADIATOR COVER

Ø mm 50+32 Luce / Distance 7 cm Spessore / Thickness 2 mm

Il coprithermo in PVC è uno strumento fondamentale per la protezione dei bambini da radiatori e termoconvettori. Di dimensioni variabili a seconda delle esigenze, la distanza tra i tubi verticali permette il passaggio del calore senza che i bambini si scottino. Disponibile in vari colori: bianco, azzurro, verde e giallo

Caratteristiche:

- Sicuro
- Ignifugo
- Atossico
- Privo di spigoli
- Resistente agli urti
- Di facile apertura per controllo e pulizia
- Stabile grazie alle staffe di supporto non apribili dai bambini



The PVC radiator cover is a fundamental tool to protect children from heaters. Dimensions vary depending on your requirements and the distance between the vertical tubes enables heat to pass without burning children. Available colours: white, light blue, green and yellow.

Features:

- Safe
- Fire resistant
- Non toxic
- Free of sharp edges
- Resistant to impacts
- Easy access to check and clean
- Stable thanks to its supporting brackets which cannot be unlocked by children



art. 197

SET 4 STAFFE COPRITERMO

SET 4 RADIATOR COVER BRACKETS

NEW

**MOBILETTI
CABINETS**

Conforme / in compliance with
EN 14073-2

La linea di mobiletti è componibile e si adatta ad ogni spazio.
Indispensabile per classi e aree gioco sempre in ordine.
Mobiletti in truciolato di alta qualità color faggio.
Le ante in laminato MDF con pomelli in faggio sono fornite
in colori assortiti.

*The cabinets line is combinable and suitable for whatever place.
Useful to keep classes and play areas always tidy. The cabinets
are made of high quality chipboard in beech shade.
The doors are made of high quality laminated MDF board with
beech knob. Supplied in assorted colours.*

MOBILETTO A 6 SCOMPARTI 6 COMPARTMENTS CABINET Dim. cm 70x44x94 h.



Art. 041
Mobiletto 6 scomparti A VISTA
6 compartments cabinet WITHOUT DOORS



Art. 042
Mobiletto 6 scomparti - 1 ANTA
6 compartments cabinet - 1 DOOR



Art. 043
Mobiletto 6 scomparti - 2 ANTE
6 compartments cabinet - 2 DOORS

MOBILETTO A 2 MENSOLE 2 SHELVES CABINET

Dim. cm 75x44x94 h.



Art. 024
Mobiletto 2 mensole
A VISTA
2 shelves cabinet
WITHOUT DOORS



Art. 025
Mobiletto 2 mensole - 2 ANTE
2 shelves cabinet - 2 DOORS

MOBILETTO A 3 MENSOLE 3 SHELVES CABINET

Dim. cm 75x44x121 h.



Art. 028
Mobiletto 3 mensole A VISTA
3 shelves cabinet WITHOUT DOORS



Art. 029
Mobiletto 3 mensole
2 ANTE INFERIORI
3 shelves cabinet
2 LOWER DOORS

**italveneta
didattica**
a better play

www.italvenetadidattica.com

**MOBILETTI
CABINETS**

Conforme / in compliance with
EN 14073-2

MOBILETTO CON CONTENITORI CABINET WITH CONTAINERS

art. 054
MOBILETTO PER CONTENITORI
CABINET FOR CONTAINERS
Dim. cm 103,5x44x94 h.



art. 055
SET 11 CONTENITORI
IN PLASTICA CON GUIDE
SET OF 11 PLASTIC
CONTAINERS WITH GUIDES
Include 7 contenitori piccoli
(cm 42,7x31x7,5 h.)
e 4 contenitori medi
(cm 42,7x31x15 h.)
Includes 7 small containers
(cm 42,7x31x7,5 h.)
and 4 medium containers
(cm 42,7x31x15 h.)



art. 056
GUARDAROBA
WARDROBE

Guardaroba a 4 ante in truciolato color faggio. Ogni ante ha uno spazio per gli indumenti e uno spazio per le scarpe.

Dimensioni cm 66x40x162 h.

Ante in laminato MDF di alta qualità fornite in colori assortiti, dim. 29,5x74,5 h.

4 modules wardrobe made of chipboard in beech shade. Each module has a space for clothes and one for shoes.

Dim. cm 66x40x162 h.

The high quality laminated MDF board doors are supplied in assorted colours, dim. 29,5x74,5 h.



ATTIVITÀ MOTORIA



ACTIVE PLAY

KIT PSICOMOTORI MOTOR SKILLS KITS

Conforme / in compliance with
UNI EN 71-1/2/3 

Kit per **stimolare la coordinazione** e per giochi in movimento, composti da aste ginniche, cerchi piatti, blocchi percorso e assi di equilibrio. Tutti i **kit** sono **adatti a gruppi di varie età** e permettono di realizzare percorsi di equilibrio **con difficoltà diverse**. Tutte le parti sono modulari e tra loro **perfettamente abbinabili**, al fine di garantire la massima flessibilità di utilizzo. Le soluzioni studiate e suggerite nelle immagini che seguono, sono state create utilizzando tutti i componenti dei vari kit, ma è possibile creare con fantasia **infiniti percorsi**.



Kits studied to develop coordination with active games. They consist of gym poles, flat hoops, course blocks and balancing slats. All our kits are suitable for children of any age and can be arranged into many courses with different difficulty to improve balance skills. All the elements are modular and can be connected to each other. The solutions proposed in the pictures below have been created using all the elements of the different kits. Endless combination can be created using imagination.



art. 102 • KIT A

composto da / includes

- 5 mattoni percorso / course blocks
- 4 basi con foro 25 mm / bases with 25 mm hole
- 4 cerchi piatti / flat hoops (1 Ø60 cm - 1 Ø65 cm - 2 Ø50 cm)
- 12 aste ginniche l. 110 cm / gym poles (110 cm long)
- 2 coni h. 30 cm senza fori / cones with no holes (30 cm h)
- 2 clip jolly supporto / jolly support clips
- 4 clip asta-asta / pole-pole clips

Kit A
composizione 1
composition 1

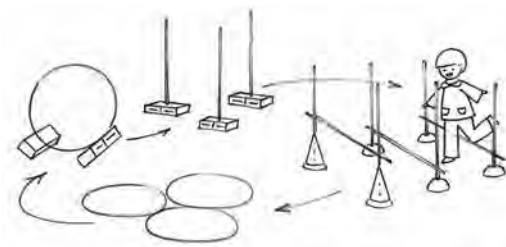

italveneta
didattica
a better play

www.italvenetadidattica.com

KIT PSICOMOTORI MOTOR SKILLS KITS

Conforme / in compliance with
UNI EN 71-1/2/3 



art. 103 • KIT B

composto da / includes

9 mattoni percorso + 24 ventose / *course blocks + 24 suction cups*

8 cerchi piatti Ø 65 cm / *flat hoops Ø 65 cm*

3 assi plastica / *plastic slats*

6 coni h. 30 cm 3 fori / *cones with 3 holes (30 cm h)*

6 clip asta-cerchio piatto / *pole-flat hoop clips*

5 aste ginniche l. 110 cm / *gym poles (110 cm long)*

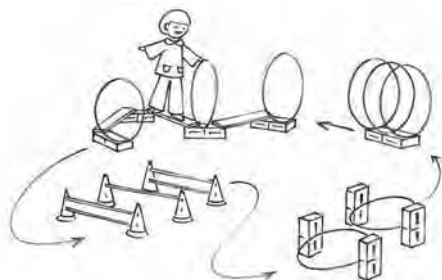

Kit B - composizione 1 / *composition 1*

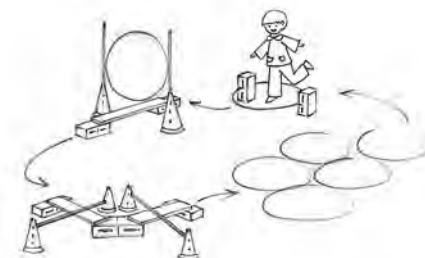

Kit B - composizione 2 / *composition 2*

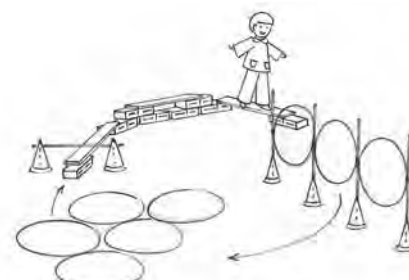

Kit B - composizione 3 / *composition 3*



art. 104 • KIT C

composto da / includes

2 cerchi piatti Ø 65 cm / *flat hoops Ø 65 cm*

5 cerchi piatti Ø 50 cm / *flat hoops Ø 50 cm*

4 coni h. 30 cm 3 fori / *cones with 3 holes (30 cm h)*

5 coni h. 30 cm 12 fori / *cones with 12 holes (30 cm h)*

6 aste ginniche l. 110 cm / *gym poles (110 cm long)*

2 clip asta-cerchio piatto / *pole-flat hoop clips*

1 set orme motorie (6 mani + 6 piedi, sottili)
set of motor tracks (6 hands + 6 feet, thin)

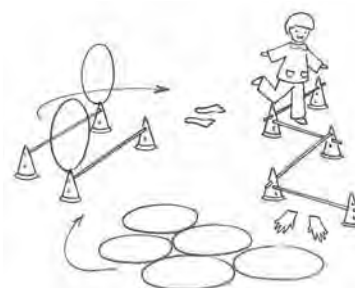

Kit C - composizione 1 / *composition 1*

KIT PSICOMOTORI MOTOR SKILLS KITS

Conforme / in compliance with
UNI EN 71-1/2/3 



art. 105 • KIT D

composto da / includes

10 mattoni percorso + 24 ventose / *course blocks + 24 suction cups*

2 cerchi piatti Ø 65 cm / *flat hoops Ø 65 cm*

4 assi plastica / *plastic slats*

2 aste ginniche l. 110 cm / *gym poles (110 cm long)*

2 clip asta-cerchio piatto / *pole-flat hoop clips*

Kit D
composizione 1
composition 1

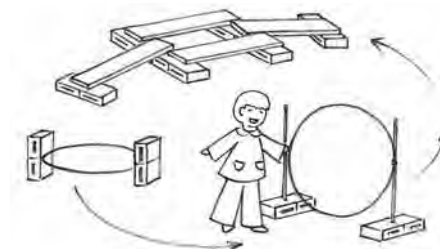

art. 106 • KIT E

composto da / includes

13 mattoni percorso + 40 ventose / *course blocks + 40 suction cups*

5 assi plastica / *plastic slats*

2 cerchi piatti Ø 65 cm / *flat hoops Ø 65 cm*

2 coni h. 30 cm 12 fori / *cones with 12 holes (30 cm h)*

8 aste ginniche l. 110 cm / *gym poles (110 cm long)*

4 clip jolly supporto / *jolly support clips*

1 segnale stradale FRECCIA / *ARROW road sign*

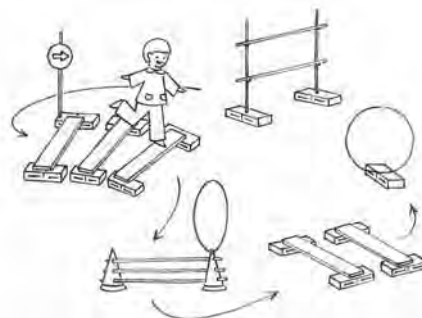

Kit E - composizione 1 / *composition 1*

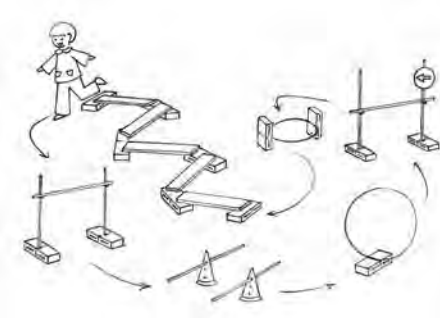

Kit E - composizione 2 / *composition 2*

KIT PSICOMOTORI
MOTOR SKILLS KITS

Conforme / in compliance with
UNI EN 71-1/2/3 

art. 121 CASETTA ASTE / HOUSE OF POLES

composto da / includes

16 aste ginniche l. 120 cm / gym poles (120 cm long)

4 mattoni giganti / mega bricks

20 clip asta-asta / pole-pole clips



art. 120 LANCIO E SEGNO / HOOP AND POLE

composto da / includes

1 asta ginnica l. 60 cm / gym pole (60 cm long)

8 cerchi piatti Ø 30 cm / flat hoops Ø 30 cm

1 mattone gigante / mega brick



art. 122 TUNNEL CERCHI / HOOP TUNNEL

composto da / includes

6 mattoni giganti / mega bricks

3 cerchi piat. Ø 65-70-80 cm / mega bricks

art. 124 SALTA-SALTA / JUMP-JUMP

composto da / includes

10 mattoni giganti / mega bricks

5 aste ginniche l. 120 cm / gym poles (120 cm long)

TRAMPOLI STILTS

Conforme / in compliance with
UNI EN 71-1/2/3 

I trampoli sviluppano la **coordinazione motoria** delle braccia e delle gambe. La parte superiore dei trampoli è zigrinata per un migliore attrito del piede e sono muniti di cordino regolabile e adattabile alla statura del bambino. Disponibili anche con gomma antiscivolo perfettamente inserita ad incastro nella parte inferiore, grazie alla quale il bambino può giocare senza scivolare e senza fare rumore.

Colori disponibili:
rosso, giallo, verde, blu.



Stilts develop **arm and leg coordination**. The nonslip tread on the top of the stilts guarantee a better grip and the adjustable rope allows to adapt them to the child's height. Also available with non-slip rubber which slots onto the bottom of the stilts, and allow children to play without slipping or making noise.

Available colours:
red, yellow, green and blue.

art. 141 art. 142

PAIA DI TRAMPOLI CON GOMMA ANTISCIVOLO PAIA DI TRAMPOLI SENZA GOMMA ATISCIVOLO
PAIR OF STILTS WITH NON-SLIP RUBBER PAIR OF STILTS WITHOUT RUBBER



Appoggio antiscivolo
Non-slip support



italveneta
didattica
a better play

www.italvenetadidattica.com

NEW

PERCORSO TUNNEL TUNNEL

Conforme / in compliance with
UNI EN 71-1/2/3 + A1/3 **CE**

Il percorso è composto da basi e archi che in successione formano un tunnel colorato dove i bambini potranno sperimentare giochi e abilità differenti, come la **coordinazione nello spazio e la capacità di destreggiarsi e interagire con altri bambini**. Può essere utilizzato da solo o come elemento aggiuntivo di altri percorsi motori.

*This course consists of bases and arches which, when placed one after the other, create a brightly coloured tunnel. Children can play new games and practise different skills, such as **coordination and interaction with other children**. The tunnel can be used on its own or added to other motor skills courses.*



art. 140

Composto da / includes

8 basi / bases in strong plastic

4 archi / arches

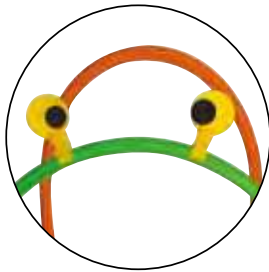

art. 145 PAIA DI "OCCHIO RANOCCHIO" / PAIR OF "FROGGY EYE"

Decora i nostri tunnel con questi simpatici occhi e trasforma i percorsi in divertenti animaletti!

Decorate our tunnels with these funny eyes and turn your courses into amusing animals!



art. 144 TUNNEL VORTICE / VORTEX TUNNEL

Composto da / includes

1 base blu 100x25 cm con 2 scanalature / blue base 100x25 cm with 2 grooves

9 cerchi colorati / coloured hoops

Ideato per creare nuovi percorsi in qualsiasi ambiente grazie alla base in soffice Polymat per l'appoggio delle ginocchia dei bambini.

Il tunnel vortice aiuta a sperimentare nuove sensazioni tattili e visive e a sviluppare le capacità motorie fin dai primi mesi di vita del bambino.

Thanks to its soft Polymat base, able to support children's knees, you can create new courses in whatever environment.

The vortex tunnel enables to experiment new tactile and visual experience and to develop motor skills from the first months of babies' life.

**italveneta
didattica**
a better play

www.italvenetadidattica.com

OSTACOLI MORBIDI SOFT HURDLES

Conforme / in compliance with
UNI EN 71-1/2/3 + A1/3 CE

La nostra nuova sezione di creazioni morbide in Polymat è adatta anche ai bambini di età inferiore ai 3 anni.

Gli ostacoli, in materiale flessibile, robusto e atossico, sono composti da elementi ad incastro dai colori brillanti. Ideali per creare nuove composizioni e sviluppare le capacità psicomotorie dei più piccoli.

Our new section of Polymat soft creations is suitable also for children under 3 years.

In flexible, sturdy and non-toxic material, the obstacles consist of bright-coloured fitting elements.

They are perfect to create new compositions and develop children' motor skills.



art. 118
OSTACOLO MORBIDO - 3 ALTEZZE
SOFT HURDLE - 3 HEIGHTS

Composto da / includes

- 2 basi / bases

- 2 supporti graduati / graduated supports
15 - 30 - 45 cm

- 3 bastoni morbidi / soft sticks



art. 119
SET 4 OSTACOLI MORBIDI - 4 ALTEZZE
SET 4 SOFT HURDLES - 4 HEIGHTS

Set composto da/ includes

- 8 basi / bases

- 8 supporti in varie altezze/ supports in different heights
10 - 20 - 30 - 40 cm

- 4 bastoni morbidi / soft sticks

SALTARELLO
Conforme / in compliance with
UNI EN 71-1/2/3 

art. 094

SALTARELLO GRANDE / LARGE "SALTARELLO"

composto da / includes

6 coni h. 30 cm 3 fori / cones with 3 holes (50 cm h)

6 cerchi piatti Ø 65 cm / flat hoops Ø 40 cm

6 aste ginniche l. 70 cm / gym poles (70 cm long)

6 aste ginniche l. 80 cm / gym poles (80 cm long)



art. 095

SALTARELLO PICCOLO / SMALL "SALTARELLO"

composto da / includes

6 coni h. 30 cm 3 fori / cones with 3 holes (30 cm h)

6 cerchi piatti Ø 40 cm / flat hoops Ø 40 cm

3 aste ginniche l. 60 / gym poles (60 cm long)

3 aste ginniche l. 70 cm / gym poles (70 cm long)

3 aste ginniche l. 80 cm / gym poles (80 cm long)



art. 096

MULTISALTARELLO GRANDE

LARGE "MULTISALTARELLO"

composto da / includes

8 coni h. 50 cm 12 fori / cones with 12 holes (50 cm h)

8 cerchi piatti Ø 50 cm / flat hoops Ø 50 cm

8 aste ginniche l. 80 cm / gym poles (80 cm long)

8 aste ginniche l. 70 cm / gym poles (70 cm long)

art. 097

MULTISALTARELLO PICCOLO

SMALL "MULTISALTARELLO"

composto da / includes

8 coni h. 30 cm 12 fori / cones with 12 holes (30 cm h)

8 cerchi piatti Ø 40 cm / flat hoops Ø 40 cm

10 aste ginniche l. 60 / gym poles (60 cm long)

10 aste ginniche l. 80 cm / gym poles (80 cm long)



OSTACOLI HURDLES

Conforme / in compliance with
UNI EN 71-1/2/3 

Ostacolo telescopico basculante, prodotto con tubo in materiale plastico di alta qualità, colorato, antiurto e antinfortunistico. **Regolabile in altezza da 40 a 70 cm**, con traversa rivestita in gomma per attutire l'impatto in caso di urto. Adatto per avvicinare i più piccoli all'atletica leggera.

*Balancing hurdle made of high quality, coloured, shockproof, plastic with rounded tips pole. **Height can be adjusted from 40 to 70 cm** and the rubber coated crossbar softens any possible impact. Perfect for a first approach to athletics.*

art. 174 OSTACOLO "JUMP" / "JUMP" HURDLE

Telescopico
Telescopic



Basculante
Swing

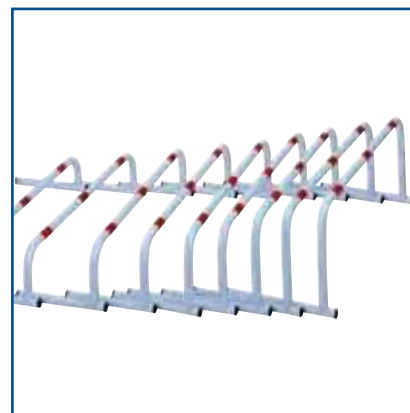
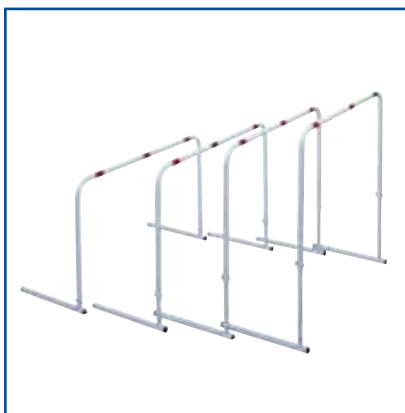

art. 420
SET 3 OSTACOLI IN FERRO
SET OF 3 IRON HURDLES
serie di 3 ostacoli graduabili
set of 3 height-adjustable hurdles
h. 30-40-50 cm

art. 421
SET 4 OSTACOLI IN FERRO
SET OF 4 IRON HURDLES
4 ostacoli graduabili
4 height-adjustable hurdles
h. 60-70-80-90 cm

art. 422
SET 10 OSTACOLI IN FERRO
SET OF 10 IRON HURDLES
Serie 10 ostacoli fissi "Over"
Set of 10 not height-adjustable
"Over" hurdles
h. da 12 a 30 cm/12 to 30 cm h.

italveneta
didattica
a better play

www.italvenetadidattica.com

PERCORSO EQUILIBRIO BALANCING COURSE

Conforme / in compliance with
UNI EN 71-1/2/3 

art. 061 PERCORSO EQUILIBRIO / BALANCING COURSE

composto da / includes

5 assi in plastica - lunghezza cm 75 / plastic slats - 75 cm long

6 mattoni percorso / course blocks

24 ventose / suction cups

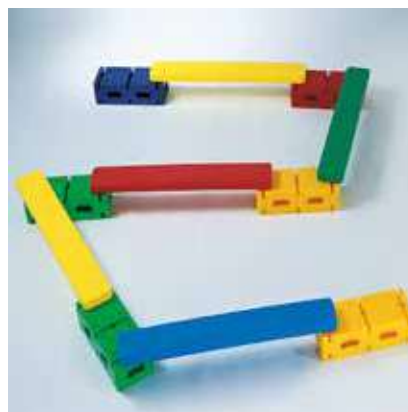

Sistema di incastro
con superficie zigrinata
antiscivolo
*Snap-fit system with
non-slip surface*

I percorsi proposti da Italveneta Didattica, sono ideali per l'attività fisica dei bimbi e per i giochi di equilibrio. Il percorso è creato con assi e mattoni in materiale plastico con fori e fessure per l'inserimento di cerchi o aste, e ventose per aderire completamente a qualsiasi tipo di pavimentazione. Con i vari elementi è possibile costruire diversi percorsi di equilibrio per l'**apprendimento motorio spaziale**, con o senza ostacoli e difficoltà, adattabili a qualsiasi età.

Italveneta Didattica obstacle courses are ideal to help children exercising and improving their balance. Their plastic slats and blocks have holes and slots where hoops or poles can be connected. Suction cups anchor to any type of floor. The different components can build many balance courses, with or without obstacles. Difficulty can be adapted to any age for spatial motor training.

BLOCCO PERCORSO
COURSE BLOCK

Conforme / in compliance with
UNI EN 71-1/2/3 

art. 098 **art. 099**
BLOCCO PERCORSO **SET 4 VENTOSE + 3 PERNI**
COURSE BLOCK **SET OF 4 SUCTION CUPS + 3 CONNECTING PINS**
36x14,5x10 cm per mattone /for block

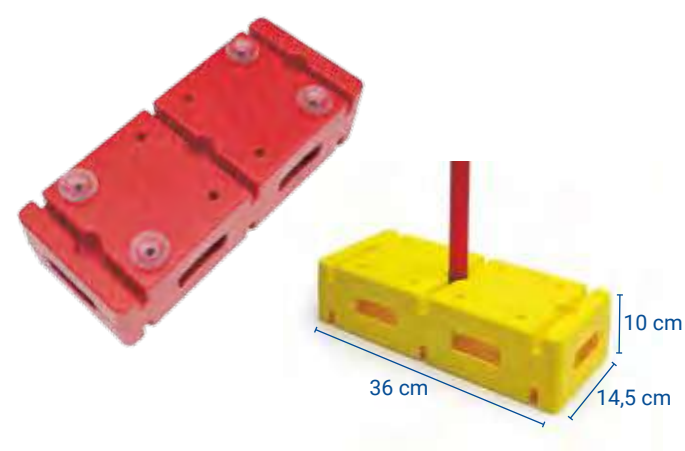
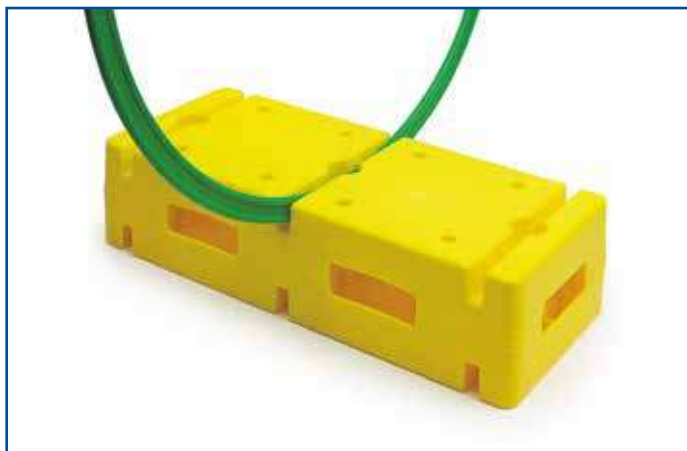
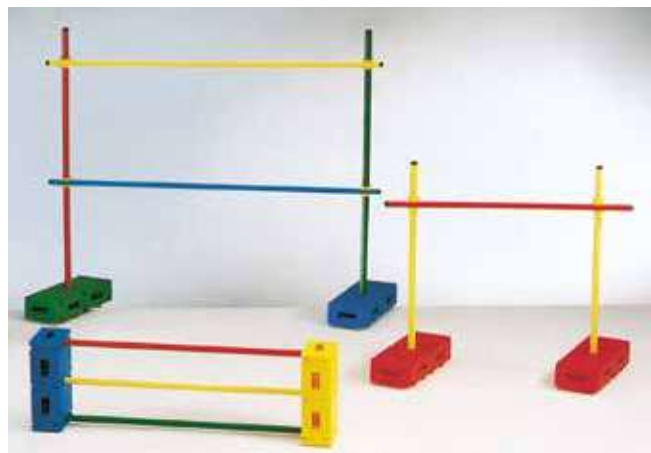

Blocco percorso realizzato in materiale plastico nei 4 colori base, con fori e scanalature per inserimento di cerchi piatti e aste sezione 25 mm.
Disponibile in 4 colori: giallo, verde, blu, rosso.

*Plastic blocks with holes and slots where flat hoops and poles (with 25 mm section) can be inserted.
Available in 4 colours: yellow, green, blue and red.*

MATTONI PERCORSO COURSE BLOCKS

Conforme / in compliance with
UNI EN 71-1/2/3 

Mattoni stabili e con **superficie antiscivolo**, che si incastrano l'uno all'altro a formare percorsi diversi ed esercizi di equilibrio.

Con questi percorsi i bambini acquisiscono maggiore sicurezza delle proprie capacità motorie, vincono eventuali difficoltà di equilibrio ed esercitano la coordinazione dei movimenti.



*These special stable blocks with their **non-slipping surface** can be fitted together and create many different combinations to improve balance and motor skills. Playing with these obstacle courses, children gain confidence in their movements, overcome any difficulties with balance and practise their coordination.*

art. 059 CONFEZIONE MATTONI PERCORSO DRITTO SET STRAIGHT COURSE BLOCK

conf. da 10 pezzi assortiti
in 4 colori: rosso, giallo,
verde, blu
*set of 10 assorted pieces
in 4 colours: red, yellow,
green and blue*

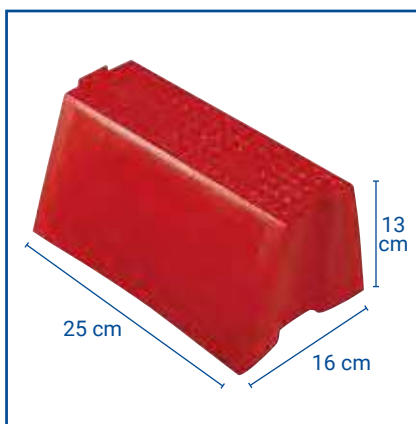

art. 060 CONFEZIONE 10 MATTONI PERCORSO CURVO SET 10 CURVED COURSE BLOCKS

conf. da 10 pezzi assortiti
in 4 colori: rosso, giallo,
verde, blu
*set of 10 assorted pieces in
4 colours: red, yellow, green
and blue*

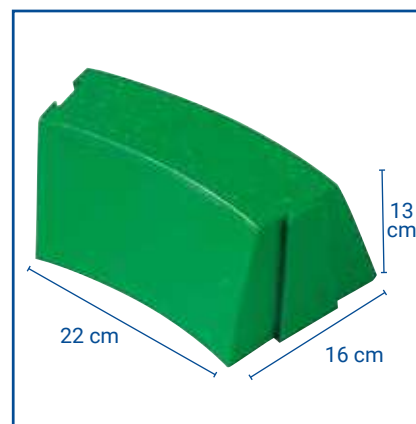

La lavorazione superiore del mattone "zigrinato antiscivolo", tutela il bambino che sale dall'eventuale caduta e lo aiuta a sentirsi più sicuro.

As children climb, the block's non-slipping milled surface prevents them from falling and helps them feel safer.

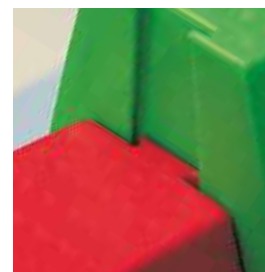

Mattoni con sistema ad incastro
Blocks slot together

PERCORSO SEMISFERICO SEMI-SPHERICAL COURSE

Conforme / in compliance with
UNI EN 71-1/2/3 

Percorso composto da 12 mattoni dritti e 12 curvi, con zigrinatura antiscivolo, disponibili nei colori giallo, blu, rosso e verde. Gli elementi, incastrandosi tra di loro in modo sicuro e stabile, formano un percorso vario e colorato; i mattoni sono realizzati in forma semicilindrica per aumentare il grado di difficoltà, permettendo al bambino di mettere alla prova e **migliorare il suo equilibrio e la sua destrezza.**



*This course consists of 12 straight and 12 curved non-slipping milled surfaced blocks, available in yellow, blue, red and green. The blocks fit together safely and securely to build a varied, brightly coloured courses; the semi-spherical shape is designed to increase difficulty, allowing children to test and **improve their balance and ability.***

art. 070

PERCORSO SEMISFERICO (24 pezzi: 12 dritti e 12 curvi) **SEMI-SPHERICAL COURSE** (24 pieces: 12 straight and 12 curved)

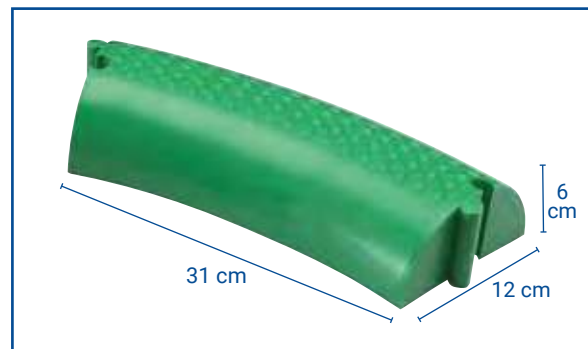
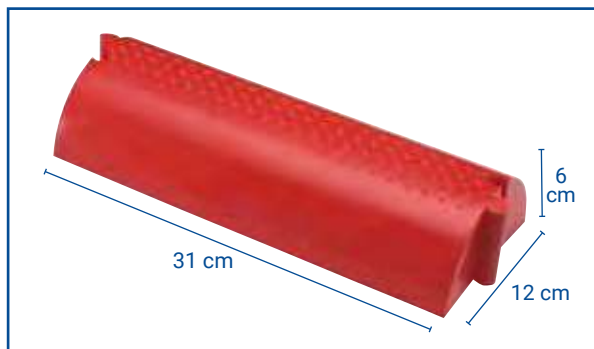

italveneta
didattica
a better play

www.italvenetadidattica.com

ELEMENTI DI PSICOMOTRICITÀ
MOTOR SKILL TOYS

Conforme / in compliance with
UNI EN 71-1/2/3 

In materiale plastico, **antiurto**
e antinfortunistico.
Le estremità sono chiuse con
tappi arrotondati antigraffio.
Compatibile con la base per
ostacoli (art. 109) e con coni
h. 30 cm e h. 50 cm.



In shockproof safety plastic.
The ends are sealed with rounded
scratchproof caps.
Compatible with the base for
obstacles (art. 109), 30 cm (h) and
50 cm (h) cones.

ASTE GINNICHE SEZ . 25 mm
GYM POLES WITH 25 mm SECTION

art. 072 ASTA l. 50 cm / *POLE 50 cm long*
art. 073 ASTA l. 60 cm / *POLE 60 cm long*
art. 074 ASTA l. 65 cm / *POLE 65 cm long*
art. 075 ASTA l. 70 cm / *POLE 70 cm long*
art. 076 ASTA l. 80 cm / *POLE 80 cm long*

art. 077 ASTA l. 90 cm / *POLE 90 cm long*
art. 078 ASTA l. 100 cm / *POLE 100 cm long*
art. 079 ASTA l. 110 cm / *POLE 110 cm long*
art. 080 ASTA l. 120 cm / *POLE 120 cm long*

CLIP SUPPORTO Giunti universali per collegamento tra
aste e cerchi di varie sezioni (25 mm o 30 mm).

SUPPORT CLIP Universal joints to connect poles and hoops
of different sections (25 mm or 30 mm).



ELEMENTI DI PSICOMOTRICITÀ MOTOR SKILL TOYS

Conforme / in compliance with
UNI EN 71-1/2/3 

CERCHI NYLON SEZIONE PIATTA *NYLON HOOPS WITH FLAT SECTION*

Cerchi realizzati in **materiale flessibile di alta qualità**, a memoria di forma, ovvero riprendono immediatamente l'aspetto originario. **Molto resistenti.**

*These hoops are made of a **high quality, flexible, shapememory material** which immediately returns to its original shape. **Highly resistant.***

CERCHI TUBOLARI SEZIONE 20 mm *TUBULAR HOOPS WITH 20 mm SECTION*

Per danza e ginnastica ritmica. Sono leggeri, resistenti, **antiurto e antigraffio**. Uniti all'estremità con un perno interno.

The hoops are light, strong, shockproof and scratchproof. Their ends are connected by an internal pin.

art. 081
CERCHIO PIATTO
FLAT HOOP Ø 30 cm

art. 082
CERCHIO PIATTO
FLAT HOOP Ø 40 cm

art. 083
CERCHIO PIATTO
FLAT HOOP Ø 50 cm

art. 084
CERCHIO PIATTO
FLAT HOOP Ø 60 cm

art. 085
CERCHIO PIATTO
FLAT HOOP Ø 65 cm

art. 086
CERCHIO PIATTO
FLAT HOOP Ø 70 cm

art. 087
CERCHIO PIATTO
FLAT HOOP Ø 80 cm

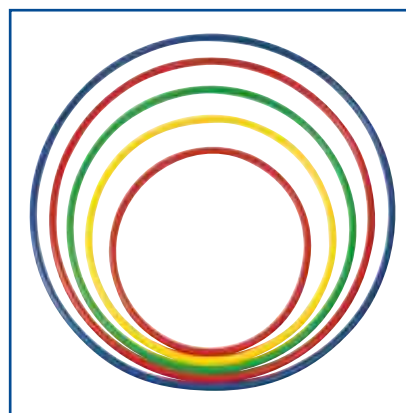
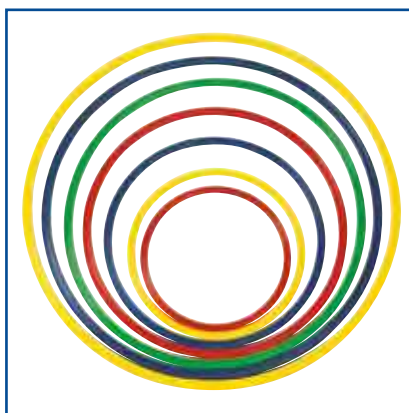

art. 088
CERCHIO TUBOLARE
TUBULAR HOOP Ø 50 cm

art. 089
CERCHIO TUBOLARE
TUBULAR HOOP Ø 60 cm

art. 091
CERCHIO TUBOLARE
TUBULAR HOOP Ø 70 cm

art. 092
CERCHIO TUBOLARE
TUBULAR HOOP Ø 80 cm

art. 093
CERCHIO TUBOLARE
TUBULAR HOOP Ø 90 cm

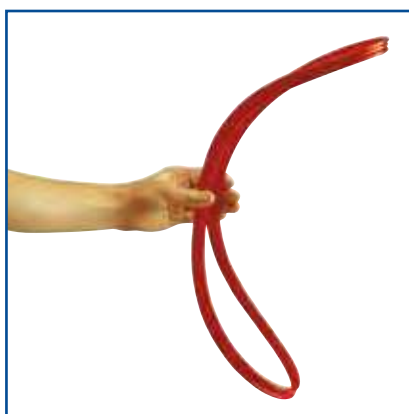

Flessibile e indistruttibile
Flexible and indestructible



Sezione tonda
Round section

CONI CONES

Conforme / in compliance with
UNI EN 71-1/2/3 

Prodotti in materiale di alta qualità, con fessure nella parte superiore per l'inserimento di aste o cerchi e forati lateralmente in modo simmetrico per l'inserimento di aste all'altezza desiderata. Disponibile in 4 colori: rosso, giallo, verde e blu.

Made of a high quality material, with slots on the top to insert poles or hoops and symmetrical holes on the sides to connect poles at different heights. Available in 4 colours: red, yellow, green and blue.



art. 062 CONO SENZA FORI h. 30 cm
CONE WITH NO HOLES (30 cm h)

art. 063 CONO CON 3 FORI h. 30 cm
CONE WITH 3 HOLES (30 cm h)

art. 064 CONO CON 12 FORI h. 30 cm
CONE WITH 12 HOLES (30 cm h)



art. 067 CONO SENZA FORI h. 50 cm
CONE WITH NO HOLES (50 cm h)

art. 068 CONO CON 3 FORI h. 50 cm
CONE WITH 3 HOLES (50 cm h)

art. 069 CONO CON 12 FORI h. 50 cm
CONE WITH 12 HOLES (50 cm h)



Nuova base rotonda
New round base



Fessure profonde 4 cm, a croce sul cono, a sostegno dei cerchi
4 cm deep cross-shaped slots on the cone to hold hoops



art. 109
BASE SFERICA
SPHERICAL BASE

DELIMITATORI MARKERS

Conforme / in compliance with
UNI EN 71-1/2/3 

Delimitatore realizzato in **materiale plastico ultra resistente** grazie alle venature circolari. Disponibile nei 4 colori giallo, blu, rosso e verde. Il delimitatore maxi permette la creazione di percorsi d'allenamento per sportivi di tutte le età. Con pratico raccoglitore.

This plastic marker is ultra-resistant thanks to its circular hints. Available in 4 colours: yellow, blue, red and green. The maxi marker allows to create training courses for sportslovers of all ages. Available with practical stacking device.

In plastica morbida, colorata e atossica. Ideali per delimitare aree interne ed esterne, nell'attività sportiva, ludica e psicomotoria. Con pratico raccoglitore.

These non-toxic plastic coloured markers come with practical stacking device. Ideals to mark internal and external areas for sports, fun or motor skills activities.

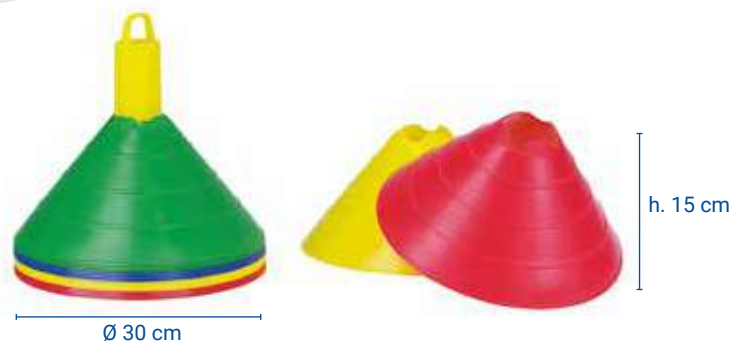

art. 198 SET 48 DELIMITATORI / SET OF 48 MARKERS
art. 199 SET 24 DELIMITATORI / SET OF 24 MARKERS

art. 405 SET 12 DELIMITATORI MAXI / SET OF 12 MAXI MARKERS
art. 404 SET 24 DELIMITATORI MAXI / SET OF 24 MAXI MARKERS



italveneta
didattica
a better play

www.italvenetadidattica.com

CARRELLO TROLLEY

Conforme / in compliance with
UNI EN 71-1/2/3 

art. 146

CARRELLO PSICOMOTORIO IN LEGNO (115x50x90 cm) WOODEN TROLLEY FOR MOTOR SKILLS GYM SET (115x50x90 cm)

Il carrello per kit psicomotori è stabile e solido. Quattro ruote ne rendono più facile lo spostamento. Nella parte laterale e superiore è dotato di un foro per l'inserimento di aste o pali lunghi. Completo di ruote.

This trolley for motor skills kits is stable and solid and the wheels fitted to the base make it easy to be moved. Poles can be stored on the slot on the top and sides of the trolley. Supplied with wheels.



art. 147

KIT PER PALESTRA / GYM SET

trolley non incluso / trolley not included

composto da / includes

- 4 coni h. 30 cm 12 fori / cones with 12 holes (30 cm h)
- 4 palle per ritmica da 280 gr. / 280 g balls for rhythmic gymnastics
- 2 coppie clavette moplen 155 gr. / pairs of Moplen clubs (155 g each)
- 4 coppie trampoli (senza gomma) / pairs of stilts (without rubber)
- 20 clip assortite / assorted clips
- 4 mattoni percorso / course blocks
- 4 confezioni 4 ventose / packs of 4 suction cups
- 4 aste ginniche l. 100 cm / gym poles (100 cm long)
- 1 confezione da 4 tagli corda 2,5 m / pack of 4 ropes 2.5 m long
- 4 cerchi piatti Ø 30 cm / flat hoops Ø 30 cm
- 4 cerchi piatti Ø 40 cm / flat hoops Ø 40 cm
- 4 cerchi piatti Ø 50 cm / flat hoops Ø 50 cm
- 4 cerchi piatti Ø 60 cm (o 65cm) / flat hoops Ø 60 cm (or 65cm)
- 8 palline in spugna Ø 70 mm / small foam rubber balls Ø 70 mm
- 4 palle in spugna Ø 200 mm / foam rubber balls Ø 200 mm

CARRELLI E CONTENITORI TROLLEYS AND CONTAINERS

Conforme / in compliance with
UNI EN 71-1/2/3 

art. 137
**CONTENITORE IN PLASTICA
PER PALLONI
E ALTRI OGGETTI**
(completo di rete)
**PLASTIC CONTAINER
FOR FOOTBALLS
AND OTHER OBJECTS**
(including net)

Grazie alle ruote piroettanti
è maneggevole e facile da
spostare. Ottima capienza.
Molto robusto. Realizzato in
tubolare Ø 50 cm
mis. h. 50x60x60 cm.
*The swivelling wheels make the
container easy to handle and
move. Excellent capacity.
Very sturdy trolley made of
Ø 50 cm tubular hoops
50 (h) x60x60 cm*



art. 490
**CONTENITORE
PORTA PALLONI**
(15/20 PALLONI)
FOOTBALL TROLLEY
(15/20 FOOTBALLS)

In ferro zincato con sacca blu,
completo di ruote.
Dim. 60x60x90 cm
*Galvanised iron trolley with
a plastic blue bag and wheels.
60x60x90 cm*



art. 491 **CONTENITORE PORTA PALLONI (20/25 PALLONI)**
FOOTBALL TROLLEY (20/25 FOOTBALLS)

In ferro verniciato bianco con sacca blu, completo di ruote.
Dim. 80x55x60 cm
*White coated iron trolley with a plastic blue bag and wheels.
80x55x60 cm*

art. 492 **CARRELLO PORTA PALLONI (35/40 PALLONI)**
FOOTBALL BIN (35/40 FOOTBALLS)

In ferro verniciato giallo, completo di ruote e lucchetto a pareti
smontabili. Dim. 100x75x90 cm
*Yellow coated iron bin with wheels, lock and removable sides.
100x75x90 cm*

PORTA CALCIO GOALPOSTS

Conforme / in compliance with
UNI EN 71-1/2/3 

Porte calcio con struttura in **materiale plastico robusto, antiurto e antinfortunistico**, di facile montaggio.

Da utilizzare nel gioco del calcio, del rugby, dell'hockey, per lanci di precisione con mani e piedi. **Leggere al trasporto** ma stabili, con spigoli arrotondati, non necessitano di fissaggio al suolo e possono essere utilizzate anche all'esterno in quanto **resistenti agli agenti atmosferici**. Complete di rete.

Goalposts with a **sturdy, shockproof and safety plastic frame** easy to assemble.

Suitable for football, rugby, hockey, for precision throwing and kicking. **Light but stable**, with rounded corners, goal posts do not need anchoring to the ground and can also be used outdoors as they are designed to be **weather resistant**. Supplied with a net.



art. 169

PORTA CALCIO "LUSSO" "DELUXE" GOALPOSTS

Completa di rete - 110x170 cm
Supplied with net - 110x170 cm



art. 170

NUOVA PORTA CALCIO NEW GOALPOSTS

Completa di rete - 110x170x70 cm
Supplied with net - 110x170x70 cm

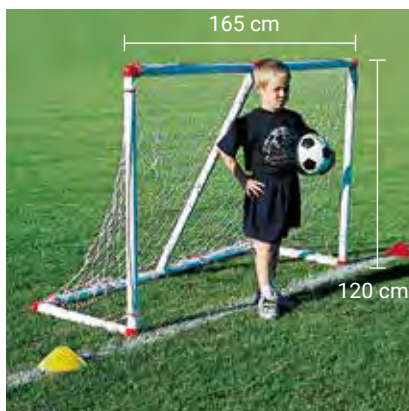

art. 171

PORTA CALCIO "ECONOMICA" "ECONOMICAL" GOALPOSTS

Completa di rete - 165x120 cm
Supplied with net - 165x120 cm



ACCESSORI PER GINNASTICA

GYM ARTICLES

Conforme / in compliance with

UNI EN 71-1/2/3 

art. 123
PAIA DI CLAVETTE
IN MOPLEN
h. 45 cm
PAIR OF MOPLEN CLUBS
h. 45 cm

155 gr - colori assortiti
155 g - assorted colours



art. 115
SET 4 TAGLI CORDA
SET OF 4 ROPES
2,5 m
2.5 m

art. 116
SET 4 TAGLI CORDA
SET OF 4 ROPES
10 m con anima
10 m with core



art. 143
ORME MOTORIE
MOTOR TRACKS

Set composto da 44 pz:
22 mani, 22 piedi.
Disponibile in 2 colori:
rosso e verde.
Set of 44 pcs:
22 hands, 22 feet.
Available in 2 colors: red
and green.

art. 175 DADO IN SPUGNA lato 160 mm / FOAM RUBBER DICE side 160 mm

art. 176 PALLA RUGBY / RUGBY BALL

art. 177 PALLA Ø 70 mm / LITTLE BALL Ø 70 mm
disponibile in 4 colori / available in 4 colours

art. 178 PALLA Ø 120 mm / BALL Ø 120 mm
disponibile in 4 colori / available in 4 colours

art. 179 PALLA Ø 200 mm / BALL Ø 200 mm
disponibile in 4 colori / available in 4 colours

art. 180 PALLA BASKET Ø 170 mm / BASKET BALL Ø 170 mm

art. 181 PALLA CALCIO BICOLORE Ø 200 mm / TWO-COLOUR FOOTBALL Ø 200 mm
con disegno pentagoni / with pentagons



italveneta
didattica
a better play

www.italvenetadidattica.com

ATTIVITÀ RICREATIVA



RECREATIONAL ACTIVITIES

italveneta
didattica
a better play

www.italvenetadidattica.com

MATTONI BRICKS

Conforme / in compliance with
UNI EN 71-1/2/3 

Mattoni maxi / Maxi bricks



8 impronte con ruote
8 studs with wheels
cm 12,5x6,3 h7,5



8 impront
8 studs
cm 12,5x6,3 h7,5



4 impronte
4 studs
cm 6,3x6,3 h7,5



tetto a punta
pointed brick
cm 6,3x6,3 h7,5



tetto piatto
flat brick
cm 6,3x6,3 h7,5

Mattoni bassi / Half bricks



8 impronte / *8 studs*
cm 12,5x6 h3,5



4 impronte / *4 studs*
cm 6x6 h3,5



2 impronte / *2 studs*
cm 3x6 h3,5

La linea di mattoni ad incastro di Italveneta Didattica è uno strumento di gioco e un ausilio didattico. I bambini possono realizzare, con estrema facilità, forme e figure diverse dando libero sfogo alla fantasia.

Caratteristiche:

- sicuri e atossici
- in plastica morbida antiurto
- non sono soggetti ad usura
- colori brillanti e resistenti
- forme varie e modulari che stimolano la creatività e la fantasia
- dimensioni variabili a seconda dello sviluppo della manualità del bambino
- incastro che garantisce facilità d'uso e stabilità delle costruzioni realizzate.



Italveneta Didattica building blocks are both a great toy and a teaching aid. Children can create different shapes and forms using their imagination.

Features:

- safe and non-toxic
- in soft shockproof plastic
- durable material
- bright, long-lasting colours
- various modular shapes which stimulate creativity and imagination
- easy to fit and to make sturdy creations
- interlocking bricks are easy to use and creations are sturdy

MATTONI BRICKS

Conforme / in compliance with
UNI EN 71-1/2/3 

art. 001

52 MATTONI / 52 BRICKS

confezione in sacco composto da
plastic bag containing

- *7 mattoni alti 8 impronte / maxi bricks with 8 studs*
- *35 mattoni bassi mix da 2-4-8 impront
mix half bricks with 2-4-8 studs*
- *2 mattoni piatti / flat bricks*
- *2 mattoni punta / pointed bricks*
- *2 trenini con ruote / trains with wheels*

art. 002

30 MATTONI "MIX" / 30 "MIX" BRICKS

confezione in sacco composto da
plastic bag containing

- *4 mattoni alti 8 impronte / maxi bricks with 8 studs*
- *2 mattoni alti 4 impronte / maxi bricks with 4 studs*
- *21 mattoni bassi mix da 2-4-8 impronte
mix half bricks with 2-4-8 studs*
- *2 trenini con ruote / trains with wheels*
- *1 mattone piatto / flat brick*
- *1 mattone punta / pointed brick*



art. 004

105 MATTONI / 105 BRICKS

confezione in cartone composto da
cardboard box containing

- *50 mattoni alti 8 impronte / bricks with 8 studs*
- *24 mattoni alti 4 impronte / bricks with 4 studs*
- *12 mattoni piatti / flat bricks*
- *12 mattoni punta / pointed bricks*
- *7 trenini con ruote / trains with wheels*

art. 005

55 MATTONI / 55 BRICKS

confezione in cartone composto da
cardboard box containing

- *24 mattoni alti 8 impronte / bricks with 8 studs*
- *12 mattoni alti 4 impronte / bricks with 4 studs*
- *6 mattoni piatti / flat bricks*
- *6 mattoni punta / pointed bricks*
- *7 trenini con ruote / trains with wheels*



NEW

CONTENITORI TOY BOXES

Conforme / in compliance with
UNI EN 71-1/2/3 CE

art. 026 CONTENITORE AD INCASTRO "SMALL" SMALL SORTER BOX

Dim.: cm 20,5x33,5x16,5 h.

art. 027 CONTENITORE AD INCASTRO "BIG" BIG SORTER BOX

Dim.: cm 30,5x46,5x18,5 h.

art. 010 CONTENITORE PORTAGIOCHI TOY BOX

Disponibile in due colori
(rosso e giallo)
e due diverse misure.

Available in 2 colours
(red and yellow)
and 2 sizes.

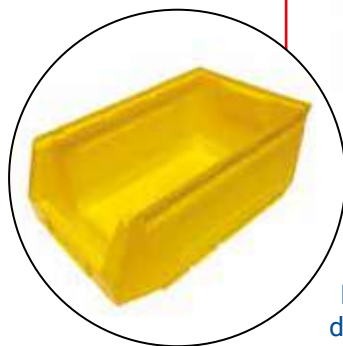

Contenitore **impilabile ad incastro, maneggevole e resistente** per riordinare oggetti di varie dimensioni. La bocca frontale consente ai bambini di prelevare e riporre gli oggetti in piena autonomia.

Stackable, practical and resistant sorter box to tidy up objects of different sizes. The frontal opening enables children to take and put objects by themselves.

Pratico e robusto contenitore per riporre giochi e oggetti vari. In materiale plastico, perfettamente impilabile e sovrapponibile, con angoli arrotondati e nervature di rinforzo. Colori disponibili: rosso, verde, giallo e blu. (dim. 60x40xh. 30 cm).

Practical, sturdy box, ideal to keep toys and other objects tidy. These plastic boxes are stackable and fit together. They have rounded corners and a reinforced frame. Colours available: red, green, yellow and blue. (60x40x30 cm h.)

MATTONE GIGANTE MEGA BRICKS

Conforme / in compliance with
UNI EN 71-1/2/3 

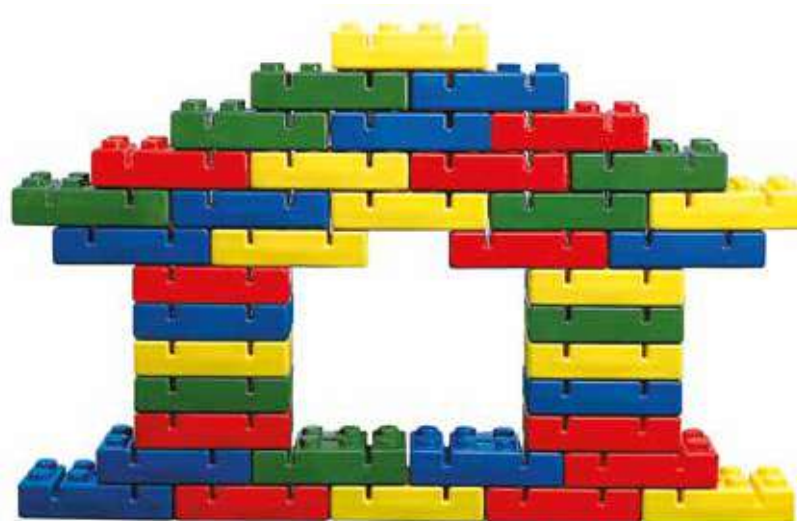

art. 008
CONF. DA 40 MATTONI GIGANTI
PACK OF 40 MEGA BRICKS

Il mattone gigante è realizzato in materiale plastico resistente e sicuro, disponibile nei 4 colori giallo, rosso, verde e blu.

Dimensioni: cm 26x13x7 h

È un gioco versatile, facilmente assemblabile che può essere utilizzato in percorsi **per l'attività psicomotoria** del bambino.

Le fessure del mattone permettono un incastro facile, sicuro e stabile di cerchi e aste. Ideale per realizzare diversi percorsi.

Il mattone è utilizzabile come costruzione gigante, ideale per favorire manualità e creatività del bambino.

Dimensione adatta anche per i più piccoli.



art. 019
CONF. DA 20 MATTONI GIGANTI
PACK OF 20 MEGA BRICKS

These mega bricks are made of tough, safe plastic and are available in 4 colours: yellow, red, green and blue.

Dimensions: cm 26x13x7 h

*They are highly versatile, easy to fit together and can be used to build obstacle courses **for motor skills activities**.*

The slots on the bricks enable an easy, safe and stable fitting of hoops and poles. Perfect to create many different courses.

Bricks can be used as giant building blocks to stimulate manuality and creativity.

Dimensions are suitable for younger children as well.



italveneta
didattica
a better play

www.italvenetadidattica.com

MATTONCINI MINI BLOCKS

Conforme / in compliance with
UNI EN 71-1/2/3 

Piccoli mattoni colorati ad incastro, prodotti in **materiale atossico di alta qualità** conforme alle norme vigenti. *Small coloured building blocks in high quality non-toxic material which complies with current safety regulations.*

Caratteristiche: *Features:*

- leggeri *• light-weight*
- maneggevoli *• easy to handle*
- in materiale che attutisce il rumore *• material which reduces noise*
- ideali per creare sempre nuove composizioni *• ideal to create endless compositions*

art. 009
BIDONCINO CON 2 KG.
MATTONCINI
(circa 300 pz.)
DRUM WITH 2 KG
OF BUILDING BLOCKS
(approx. 300 pcs.)

Bidone da 22 l
con coperchio
h. 50 cm / Ø 37 cm
22-litre drum with top



art. 012
CONTENITORE CON
4 KG. DI MATTONCINI
(circa 600 pz.)
CONTAINER WITH 4 KG
OF BUILDING BLOCKS
(approx. 600 pcs.)

Contenitore colorato
con coperchi
cm 60x40x37h
Colourful container with top



art. 006
BIDONCINO VUOTO 22 lt
22-LITRE EMPTY DRUM
Con coperchio / *With top*



art. 007
CONTENITORE VUOTO
EMPTY CONTAINER
Con coperchio / *With top*

3 misure / 3 sizes



12 impronte
12 studs



8 impronte
8 studs



4 impronte
4 studs

PUZZLE IN LEGNO
WOODEN PUZZLE

Conforme / in compliance with
UNI EN 71-1/2/3 

Puzzle in legno serigrafato super resistente e realizzato con colori atossici.

Diversi modelli per creare infiniti giochi, imparare a distinguere e riconoscere colori e forme.

Trova la soluzione più adatta a te e scegli tra: animali, viso, corpo umano, mani e piedi, mestieri e forme geometriche.

Silk-screen printed wooden puzzles extremely resistant and made with non-toxic colours.

Many different models to create endless games, learn to distinguish and recognise colours and shapes.

Find the best solution for you between: animals, face, human body, hands and feet, jobs and geometric shapes.

art. 223 e 224

CORPO UMANO A FOGLI
SOVRAPPONIBILI
SUPERPOSABLE PAPER
HUMAN BODY

Bimbo - bimba
Male - female



art. 239

SET FIGURE IN SCALA
35x10 cm
SET FIGURES ON A SCALE
Soggetti assortiti
Assorted subjects

art. 211

TAVOLA CERCHI
TABLE WITH CIRCLES



art. 227 e 228

CORPO UMANO
SNODABILE
80x30 cm
JOINTED HUMAN BODY
Bimbo - bimba
Male - female



art. 219 e 220

VISO
37x33 cm
FACE
Bimbo - bimba
Male - female



art. 235 e 236
MANI E PIEDI
HANDS AND FEET



art. 237
TAVOLA ALLACCIATURE
CLOWN
30x20 cm
CLOWN LANCING TABLE

Tavola per sviluppare la coordinazione motoria occhio-mano e imparare i vari metodi di allacciatura
Table to develop eye-hand coordination and learn how to lace up

art. 230

SET PUZZLE ASSORTITI
24x30 cm
ASSORTED PUZZLES
Animali e mestieri
Animals and jobs

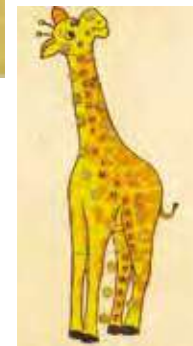

art. 231

ABC GIRAFFA
49x30 cm
ABC GIRAFFE
Puzzle per imparare l'alfabeto
Puzzle to learn the alphabet

PERLE MANIPOLATIVE MANIPULATIVE BEADS

Conforme / in compliance with
UNI EN 71-1/2/3 

art. 020

200 PERLE ROTONDE 200 ROUND BEADS

conf. da 200 perle in colori
assortiti, **in bidone**
*pack of 200 assorted
colours beads, in drum*



art. 021

400 PERLE ROTONDE 400 ROUND BEADS

conf. da 400 perle in colori
assortiti, **in bidone**
*pack of 400 assorted
colours beads, in drum*

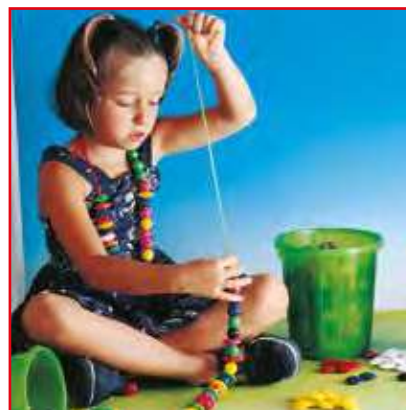

art. 022

200 PERLE PIATTE 200 FLAT BEADS

conf. da 200 perle in colori
assortiti, **in bidone**
*pack of 200 assorted
colours beads, in drum*

art. 023

400 PERLE PIATTE 400 FLAT BEADS

conf. da 400 perle in colori
assortiti, **in bidone**
*pack of 400 assorted
colours beads, in drum*



2 cm



3,1 cm

Perle manipolative assortite
in vari colori.

Sussidio particolarmente
utilizzato **per lo sviluppo
della coordinazione mo-
toria e della memoria** del
bambino, in quanto allena la
sua mente alla distinzione
delle forme e dei colori.



*Assorted manipulative beads
in different colours.*

*A useful aid to **help develop
children's coordination and
memory** because they train
their minds to recognise
different shapes and colours.*

CARTELLI STRADALI ROAD SIGNS

Conforme / in compliance with
UNI EN 71-1/2/3 

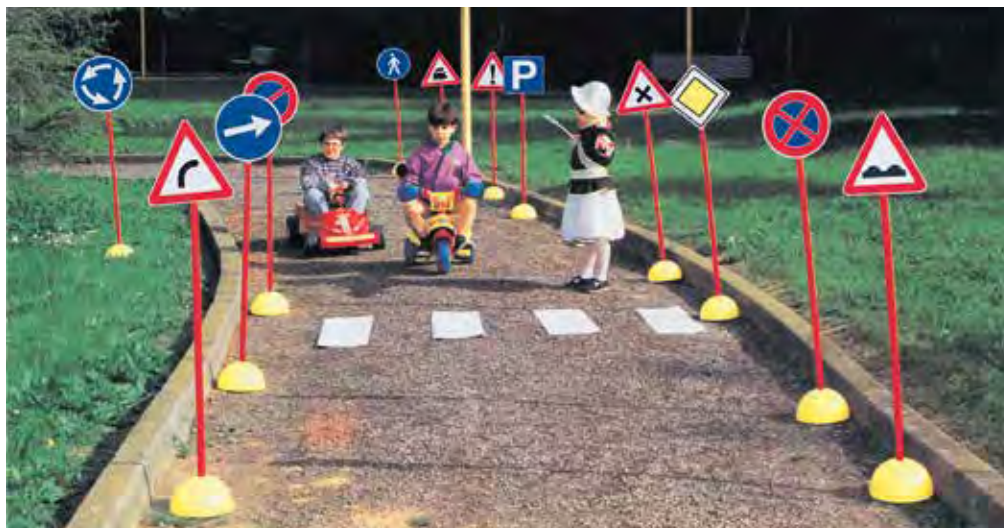

Giocare con i cartelli stradali è divertente e molto educativo: tramite il gioco i bambini conoscono i segnali di pericolo, di fermata e di divieto come da codice della strada e si improvvisano pedoni, automobilisti o vigili.

I set sono composti da:

- aste ginniche antiurto di alta qualità;
- segnali serigrafati;
- clip per un facile inserimento;
- base sferica zavorrabile.

Playing with road signs is funny and highly educational. Through playing children learn signs of danger, stop and interdiction of the current road regulation and can be pedestrians, drivers or policemen.

The sets are made up of:

- *high quality, shock-proof gym poles;*
- *silk-screen printed road signs;*
- *clip for an easy fitting;*
- *plastic round base which can be ballasted.*

ATTACCO PRATICO
E VELOCE
QUICK, PRACTICAL CLIP



SERIGRAFATO
SCREEN PRINTED

BASE ZAVORRABILE
BALLASTABLE BASE



BASE SFERICA
SPHERICAL BASE



**CARTELLI STRADALI
ROAD SIGNS**

Conforme / in compliance with
UNI EN 71-1/2/3 

art. 033 SET A

**12 SEGNALI STRADALI IN PLASTICA CON BASE
12 PLASTIC ROAD SIGNS WITH BASE**

composto da / includes

6 basi / bases

6 bastoni l. 120 cm / poles (120 cm long)

12 segnali stradali con attacco / road signs with clip



art. 035 SET B

**12 SEGNALI STRADALI IN PLASTICA CON BASE
12 PLASTIC ROAD SIGNS WITH BASE**

composto da / includes

6 basi / bases

6 bastoni l. 120 cm / poles (120 cm long)

12 segnali stradali con attacco / road signs with clip



CERCHIO
CIRCLE

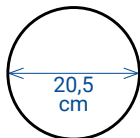

QUADRATO
SQUARE

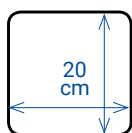

TRIANGOLO
TRIANGLE

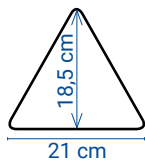

OTTAGONO
OCTAGON

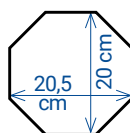

art. 036

**SET 24 SEGNALI STRADALI IN PLASTICA CON BASE
SET OF 24 PLASTIC ROAD SIGNS WITH BASE**

composto da / includes

12 basi/bases

12 bastoni l. 120 cm / poles (120 cm long)

24 segnali stradali con attacco / road signs with clips

**art 30 SEMAFORO CON LUCI
TRAFFIC LIGHT WITH WORKING LIGHTS**

cm 14x14x20,5 h.

Completo di base e asta. Luci funzionanti a ciclo manuale
o automatico (batteria non inclusa)

Supplied with base and pole. Manual or automatic light cycle
(batteries not included)



GIOCHI PER LA SABBIA SAND TOYS

Conforme / in compliance with
UNI EN 71-1/2/3 CE



Giocare con la sabbia è l'attività più semplice ed immediata per un bambino. Semplicità ed immediatezza, unite alla irrinunciabile garanzia di sicurezza, sono le caratteristiche di questi strumenti di gioco:

- realizzati in plastica morbida e atossica
 - resistono al calore del sole
 - non si deformano
- resistono alla naturale azione abrasiva della sabbia
 - hanno colori resistenti alla luce solare
 - hanno forme semplici e lineari
 - senza spigoli o profili taglienti
 - hanno impugnature ergonomiche
- disponibili nei colori rosso, giallo, verde, blu e arancio

Playing with sand is one of the simplest and most immediate activities for children. Simplicity and immediacy, combined with the essential guarantee of safety, are the cornerstones of these toys:

- *made of soft, non-toxic plastic*
 - *resistant to the heat of the sun*
 - *non deformable*
- *resistant to the natural abrasive action of sand*
 - *colours do not fade in the sun*
 - *simple, linear shapes*
 - *no sharp corners or edges*
 - *anatomical handles*
- *available in red, yellow, green, blue and orange*

verde blu rosso giallo arancio
green blue red yellow orange



italveneta
didattica
a better play

www.italvenetadidattica.com

GIOCHI PER LA SABBIA
SAND TOYS

Conforme / in compliance with
UNI EN 71-1/2/3 

art. 045
SECCHIELLO PLASTICA
PLASTIC BUCKET
contiene 2 lt
holds 2 litres



art. 046
PALETTA PLASTICA
PLASTIC SHOVEL
impugnatura ergonomica
anatomical handle

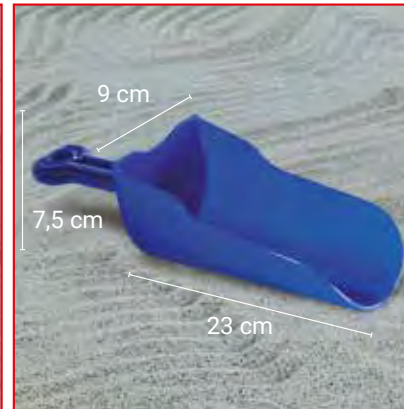

art. 047
SETACCIO PLASTICA
PLASTIC SIEVE
impugnatura ergonomica
anatomical handle



art. 053
CARRIOLA IN METALLO
2,8 kg
METAL WHEELBARROW
2.8 kg



art. 052
SET 16 FORMINE
SET OF 16 MOULDS
assortite, vari soggetti,
realizzate in plastica
morbida
*assorted shapes, made of
soft plastic*



DURATA GARANTITA
PER L'USO INTENSIVO

GUARANTEED DURABILITY
EVEN WITH INTENSIVE USE

ARTICOLI CRISTAL THE CRISTAL RANGE

Conforme / in compliance with
UNI EN 71-1/2/3 

**DISPONIBILI ALTRE FORME
MANY OTHER SHAPES AVAILABLE**

SFERE / BALLS

art. 8198

Ø 80 mm

art. 8197

Ø 100 mm

art. 8196

Ø 120 mm

art. 8195

Ø 140 mm

art. 8194

Ø 160 mm



ITEMS IN PLASTIC, POLYSTYRENE AND WOOD

*Create decorations and unique
objects with these transparent
plastic shapes.*

*A wide selection of models and
sizes: balls, stars, hearts, lockets,
small boxes, drops, discs.*

ARTICOLI IN PLASTICA,
POLISTIROLO E LEGNO
Forme varie in plastica
trasparente per **realizzare
addobbi ed oggetti unici.**

Varietà di modelli e dimensioni:
sfere, stelle, cuori, medaglioni,
scatoline, gocce, dischi.

UOVA / EGGS

art. 8199

h. 70 mm

art. 8189

h. 90 mm

art. 8193

h. 130 mm



art. 8200

**SCATOLA OVALE
OVAL BOX**
90x50 mm

STELLE / STARS

art. 8201

100 mm

art. 8202

140 mm



MEDAGLIONI / MEDALLIONS

art. 8203

80 mm

art. 8204

100 mm

GOCCE / DROPS

art. 8205

120 mm

art. 8206

150 mm

CUORI / HEARTS

art. 8207

70 mm

art. 8208

90 mm

ARTICOLI POLISTIROLO POLYSTYRENE ITEMS

Conforme / in compliance with
UNI EN 71-1/2/3 

PIÙ DI 300 SOGGETTI DISPONIBILI
OVER 300 SHAPES AVAILABLE



art. da 9001 a 9301 ARTICOLI IN POLISTIROLO

Per il bricolage e il patchwork, utili come supporto didattico e per le attività ricreative.

Diverse forme, personaggi, animali, addobbi natalizi, bamboline, ecc. disponibili in varie dimensioni.

Caratteristiche:

- materiale atossico, idoneo al contatto con sostanze alimentari
- nessun tipo di colorante
- stampaggio pressato che garantisce la compattezza del polistirolo espanso evitandone lo sgretolamento

art. from 9001 to 9301 POLYSTYRENE ITEMS

A wide selection of materials for DIY and patchwork useful as teaching aids for recreational activities.

Different shapes, characters, animals, Christmas decorations, dolls, etc. available in different sizes.

Characteristics:

- non-toxic material, used even with food
- no colourant
- pressed moulding that guarantees the compactness of the polystyrene foam preventing its crumbling



SUSSIDI DIDATTICI



TEACHING AIDS

REGOLI COLORATI CUISENAIRE RODS

Conforme / in compliance with
UNI EN 71-1/2/3 



Per l'acquisizione dei concetti matematici, i regoli o numeri in colore, risultano ancora oggi un ottimo strumento di utilizzo individuale e di gruppo per i bimbi delle scuole dell'infanzia ed elementari. Il metodo di apprendimento, diffuso in tutto il mondo, consiste nell'**acquisizione del calcolo matematico** attraverso l'associazione di COLORE-NUMERO-DIMENSIONE.

La valigetta, prodotta in materiale plastico atossico, è suddivisa all'interno in 10 comparti di forma e dimensioni diverse al fine di aiutare il bimbo all'associazione spazio-dimensione.

Così ordinati, i regoli non si muovono all'interno della valigetta che quindi, se scossa, non fa rumore.



Cuisenaire rods, or coloured number rods, are still an excellent teaching aid which can be used individually or in group to help teach basic Maths concepts to children of kindergartens and primary schools.

This internationally recognised learning method consists of performing mathematical calculations by associating COLOUR-NUMBER-SIZE.

The pieces are included in a non-toxic plastic case which is divided into ten compartments whose different shapes and sizes help children associate space and size.

Thanks to this detail, children are able to place each colour neatly in the right place, preventing any noise when the case is moved.

Con questa particolarità, il bimbo riesce a posizionare correttamente ciascun colore al suo posto in modo ordinato e corretto.

La valigetta rispetta la scala colori, ovvero la numerazione dal più piccolo al più grande (1-10) e presenta una facile apertura a pressione. I regoli sono di colore brillante e uniforme, al tatto sono **lisci, levigati** e con gli **spigoli arrotondati**.

Inoltre, sono in materiale pieno che rende anche i pezzi più piccoli **indistruttibili** e attutisce il rumore in caso di caduta.

Il bambino può apprendere con facilità:

- le equivalenze (il regolo arancio vale 10 regoli bianchi)
- le associazioni valore numerico/colore
- i primi calcoli aritmetici (rosso + verde = giallo)

*The case respects the colour scale, namely numbering from the smallest to the largest (1-10) and opens easily when pressure is applied. The Cuisenaire rods are in bright colours, **smooth and polished** to the touch, with **rounded edges**.*

*They are also solid, so even the smallest pieces are **indestructible** and all sound is "muffled" if they are dropped.*

Children can easily learn:

- *equivalences (the orange rod is worth 10 white rods)*
- *numerical value/colour associations*
- *basic arithmetic (red rod + green rod = yellow rod)*

art. 500 VALIGETTA REGOLI / RODS CASE
"originale" pz. 186 / "originale" 186 pieces

art. 506 VALIGETTA REGOLI / RODS CASE
"euro" pz. 200 / "euro" 200 pieces



**COLORI UNIFORMI,
BRILLANTI E ATOSSICI**

**BRIGHT, UNIFORM AND
NON-TOXIC COLOURS**

italveneta
didattica
a better play

www.italvenetadidattica.com

ABACO MULTIBASE MULTIBASE ABACUS

Conforme / in compliance with
UNI EN 71-1/2/3 



L'abaco multibase permette al bambino, attraverso la manipolazione delle palline, di affrontare le **prime nozioni di calcolo**.

Le palline e i bastoncini permettono una serie di giochi e di operazioni che aiutano i bambini:

- a cogliere le differenze quantitative fra numeri
- a comprendere il significato dei numeri cardinali
- a fare le prime operazioni matematiche
- a fare le prime seriazioni con una gradazione che si presta a cogliere il significato dei numeri ordinali.

L'abaco **favorisce l'apprendimento matematico** basato sulla multidimensionalità del gioco e sull'interazione fra due momenti dell'apprendimento matematico:

1- quello **qualitativo**, basato sulle differenziazioni posizionali dei numeri e sul loro uso sviluppando la consapevolezza del contare e del quantificare a più basi svolgendo operazioni di calcolo multibase;

2- quello **quantitativo**, basato sulle differenti quantità delle palline e sulla operatività manipolativa che permette le prime operazioni con i concetti matematici.

By moving the beads on the multi base abacus, children get their first experience of basic mathematical notions.

Thanks to the beads and rods, children can enjoy a number of games and perform a series of operations which help them:

- recognise the quantitative differences between numbers
- understand the meaning of cardinal numbers
- perform basic mathematical operations
- perform basic seriations which, when graded, help explain the meaning of ordinal numbers.

The abacus encourages mathematical learning due to the multidimensionality of the game and the interaction between two aspects of mathematical learning:

1- the qualitative aspect, based on the different positions of the numbers and their use, with the awareness of counting and quantifying in several bases, performing multi base calculations;

2- the quantitative aspect, based on the different quantities of beads and manipulation which allows children to perform basic operations with mathematical concepts.

art. 512

ABACO MULTIBASE MULTI BASE ABACUS

in valigetta **con guida all'interno**
in case **with instructions**

art. 037

RICAMBIO SPARE ABACUS

50 palline ABACO in sacco nylon nei 4 colori
50 beads in 4 colours in nylon bag

Con istruzioni d'uso all'interno
With instructions inside



FIGURE LOGICHE LOGICAL SHAPES

Conforme / in compliance with
UNI EN 71-1/2/3 

Sussidi in plastica, in tre colori diversi e di diverso spessore e grandezza. Sono indicati per **compiere operazioni sulla teoria degli insiemi e per l'apprendimento dei concetti fondamentali della geometria.**

Le figure logiche vengono adottate dagli insegnanti con lo scopo di far apprendere in modo concreto ed efficace alcuni concetti fondamentali quali la distinzione di forme, colori, spessori ed insiemistica.

*These teaching aids are made of plastic, come in three colours and have different thicknesses and sizes. **They are recommended when studying the theory of sets and learning basic geometry concepts.***

Logical shapes are used by teachers to teach some basic concepts such as identifying shapes, colours, thickness and set theory in a realistic and effective manner.

art. 510
VALIGETTA
FIGURE LOGICHE
IN PLASTICA
PLASTIC CASE
WITH LOGICAL SHAPES
pz. 48 di piccole dimensioni
48 small pieces



- 4 forme
4 shapes
- 3 colori: rosso - giallo - blu
3 colours: red - yellow - blue
- 2 spessori
2 thicknesses
- 2 grandezze
2 sizes



GRANDI GIOCHI



PLAYGROUND TOYS

WAGON TOY

Conforme / in compliance with

UNI EN 71-1/2/3 

UNI EN 71-8 



UN GIOCO MODULARE

Wagon Toy è un **gioco componibile** costituito da **elementi modulari ad incastro**. Facile da comporre, è **robusto, affidabile** e disponibile in **colori vivaci e resistenti agli agenti atmosferici**.

La base d'appoggio ad incastro lo rende sicuro e collocabile su qualsiasi superficie e garantisce l'incolumità del bambino durante il percorso.

Le finestrelle laterali favoriscono un'ottima illuminazione all'interno dell'ampio tunnel.

I vagoni consentono di costruire percorsi diversi tra loro con forme simpatiche e divertenti.

UN GIOCO SICURO

Wagon Toy è un **gioco sicuro**. La sua base è affidabile e garantisce l'incolumità dei bambini. Il sistema ad incastro e di aggancio rende il trenino stabile e non ne permette l'apertura involontaria.

È sicuro e in grado di supportare fino a 250 kg (circa 10 bimbi).

A MODULAR TOY

Wagon Toy is a modular toy consisting of many interlocking elements which fit together. Easy to assemble, this toy is sturdy, safe and available in bright and weather resistant colours. Wagon Toy can be used and installed on every flooring thanks to its base, ensuring the safety of the children going through it. The windows enables light inside. Endless funny solutions can be set up thanks to the wagons.

A SAFE TOY

Wagon Toy is sturdy and the base guarantees the safety of the children playing on it. The interlocking and hooking system guarantees it will not open up, and makes it stable, safe and able to hold up to 250 kg (around 10 children).



- PERCORSO LUMINOSO
- BASE D'APPOGGIO
- FORME ILLIMITATE
- ENLIGHTED COURSE
- WITH BASE
- UNLIMITED SHAPES



ELEVATA ROBUSTEZZA
STURDY

italveneta
didattica
a better play

www.italvenetadidattica.com

WAGON TOY
Conforme / in compliance with
UNI EN 71-1/2/3 
UNI EN 71-8 



MODELLO A / MODEL A
art. WT5 SET BASE / BASIC SET

composto da / includes

3 vagoni ad incastro / wagons
2 facciate / ends



MODELLO B / MODEL B
art. WT7 SET 5 VAGONI / "FIVE" SET

composto da / includes

5 vagoni ad incastro / wagons
2 facciate / ends



PROLUNGA C / EXTENSION C
art. WT3

composto da / includes



prolunga 3 vagoni / extension 3 wagons



PROLUNGA D / EXTENSION D
art. WT2

composto da / includes

prolunga 2 vagoni / extension 2 wagons

WAGON TOY
Conforme / in compliance with
UNI EN 71-1/2/3 
UNI EN 71-8 



blu / blue



giallo / yellow



fucsia / fuchsia



arancio / orange



verde mela / apple green

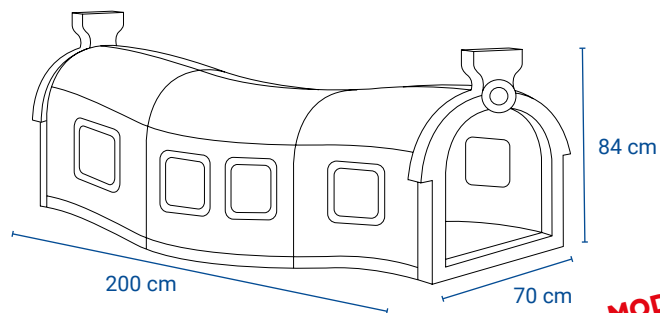
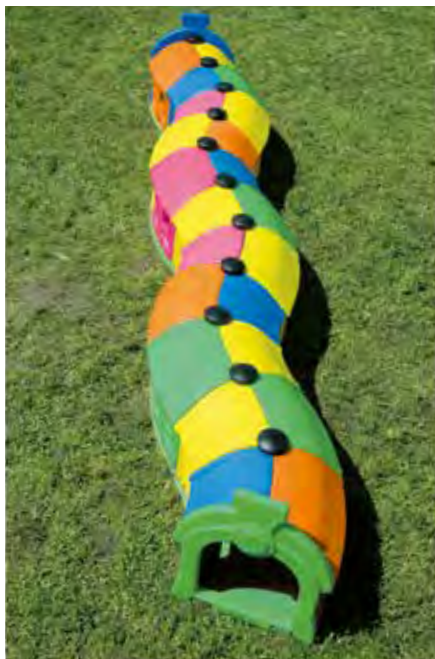

MODELLO 5 VAGONI = 324 cm!
5 WAGONS = 324 cm!

CUBIC TOY

Conforme / in compliance with
UNI EN 1176-1/3

CUBIC TOY

È facile costruire una città in miniatura, un paesaggio da fiaba, un parco giochi con Cubic Toy. Gli **elementi modulari, in robusta plastica**, permettono di realizzare cubi, cassette di varie forme e misure, ponti in una **infinita possibilità di combinazioni e colori**, senza limiti per la vostra fantasia.



*It's easy to build a miniature town, a fairytale landscape or a play area with Cubic Toy. **Modular pieces produced in sturdy plastic** will enable you to create cubes, houses of different shapes and sizes and bridges. **Endless combinations and colours** with no limit to your imagination!*

SOLIDITÀ = SICUREZZA

La verifica della sicurezza dell'attrezzatura è stata eseguita controllandone accessibilità, installazione e manutenzione.

Cubic Toy è un gioco di **massima robustezza e affidabilità**. Grazie alla sua particolare struttura può essere utilizzato in parchi gioco, palestre e piscine. Facile da comporre e leggero da trasportare, è prodotto in materiale robusto e atossico. Disponibile in sei vivaci colori, resistenti ai raggi ultravioletti ed agli agenti atmosferici. Bastano pochi pezzi per costruire un percorso divertente che potrà poi essere ampliato senza alcun limite.

SOLIDITY = SAFETY

Safety tests were carried out focusing specifically on accessibility, installation and maintenance.

*Cubic Toy is a **sturdy, reliable modular toy**. Thanks to its special structure, Cubic Toy can be used in playgrounds, gym and swimming pools. Easy to assemble and light, this strong material is completely non-toxic and safe. Available in six bright and weather-resistant colours. Add few pieces and build a funny play area!*



Grazie al pannello predisposto per il fissaggio e alle lunghe viti ad espansione, il cubo portante può essere bloccato al suolo

A special panel, complete with long screws, means the toy can be fastened to the ground

CUBIC TOY
 Conforme / in compliance with
 UNI EN 1176-1/3

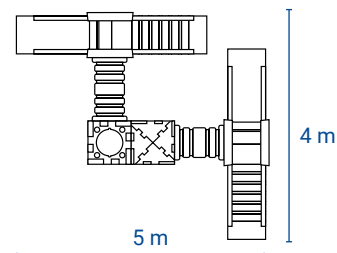

G2000

art. 301

composto da / includes

- 17 pannelli / cube sides
- 2 pannelli scaletta / ladder sides
- 2 tunnel / tunnels
- 2 scivoli grandi / large slides
- 2 scale grandi / large stairways
- 4 balaustre / protective sides
- 4 triangoli / triangles
- 1 tappo / top section

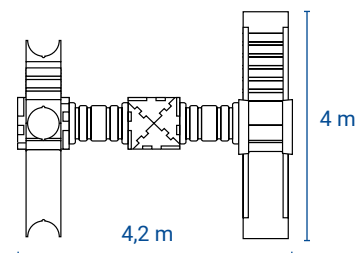

H2000

art. 157

composto da / includes

- 14 pannelli / cube sides
- 2 pannelli scaletta / ladder sides
- 2 tunnel / tunnels
- 1 scivolo grande / large slide
- 1 scala grande / large stairway
- 2 balaustre / protective sides
- 4 triangoli / triangles
- 2 scivoli-scala / step-slides
- 1 tappo / top section

CUBIC TOY

Conforme / in compliance with
UNI EN 1176-1/3

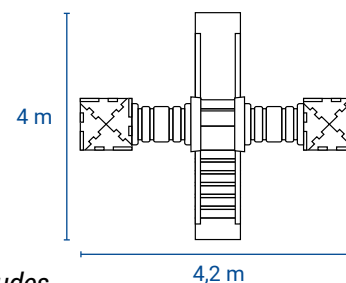

L2000

art. 158

composto da / includes

- 13 pannelli / cube sides
- 2 pannelli scaletta / ladder sides
- 2 tunnel / tunnels
- 1 scivolo grande / large slide
- 1 scala grande / large stairway
- 2 balaustre / protective sides
- 8 triangoli / triangles

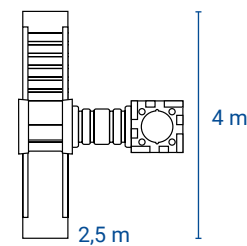

L2000

art. 159

composto da / includes

- 9 pannelli / cube sides
- 2 pannelli scaletta / ladder sides
- 1 tunnel / tunnel
- 1 scivolo grande / large slide
- 1 scala grande / large stairway
- 2 balaustre / protective sides

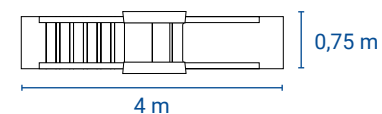

O2000

art. 300 set base / basic set

composto da / includes

- 4 pannelli / cube sides
- 1 pannello scaletta / ladder side
- 1 scivolo grande / large slide
- 1 scala grande / large stairway
- 2 balaustre / protective sides

CUBIC TOY
 Conforme / in compliance with
 UNI EN 1176-1/3

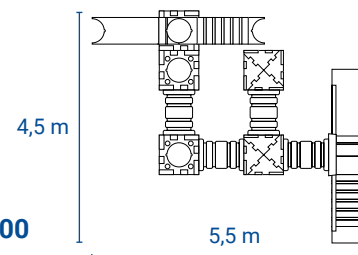

M2000

art. 302

composto da / includes

- 29 pannelli / cube sides
- 2 pannelli scaletta / ladder sides
- 4 tunnel / tunnels
- 1 scivolo grande / large slide
- 1 scala grande / large stairway
- 2 balaustre / protective sides
- 8 triangoli / triangles
- 1 tappo / top section
- 2 scivoli-scala / step-slides

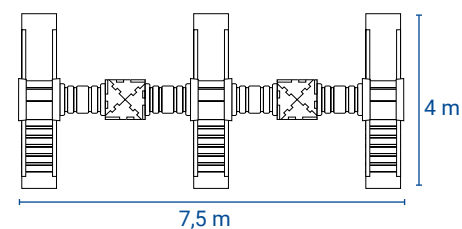

N2000

art. 303

composto da / includes

- 23 pannelli / cube sides
- 2 pannelli scaletta / ladder sides
- 4 tunnel / tunnels
- 3 scivoli grandi / large slides
- 3 scale grandi / large stairways
- 6 balaustre / protective sides
- 8 triangoli / triangles

CUBIC TOY

Conforme / in compliance with
UNI EN 1176-1/3



QUADROTTTO

art. 297

composto da / includes

8 pannelli foro Ø 50 / cube sides Ø 50

16 pannelli foro Ø 40 / cube sides Ø 40

4 nuovi tunnel Ø 50 / new tunnels Ø 50

CASTELLO A

art. 298

composto da / includes

8 pannelli foro Ø 50 / cube sides Ø 50

12 pannelli foro Ø 40 / cube sides Ø 40

16 triangoli / triangles

4 nuovi tunnel Ø 50 / new tunnels Ø 50



CASTELLO B

art. 299

composto da / includes

8 pannelli foro Ø 50 / cube sides Ø 50

14 pannelli foro Ø 40 / cube sides Ø 40

8 triangoli / triangles

4 nuovi tunnel Ø 50 / new tunnels Ø 50

CUBIC TOY

Conforme / in compliance with
UNI EN 1176-1/3



MODELLO A / MODEL A

art. 160

composto da / includes

5 pannelli / cube sides

1 pannello scaletta / ladder side

4 triangoli / triangles

1 tunnel / tunnel

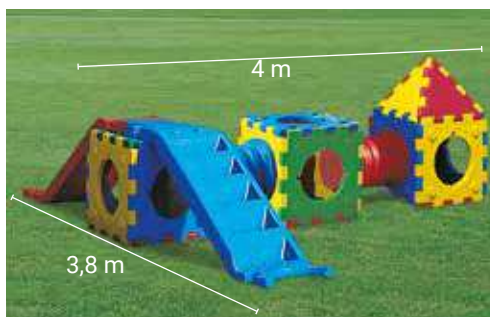

MODELLO E / MODEL E

art. 164

composto da / includes

17 pannelli / cube sides

2 tunnel / tunnels

2 scivoli-scala / step-slides

4 triangoli / triangles

1 tappo / top section

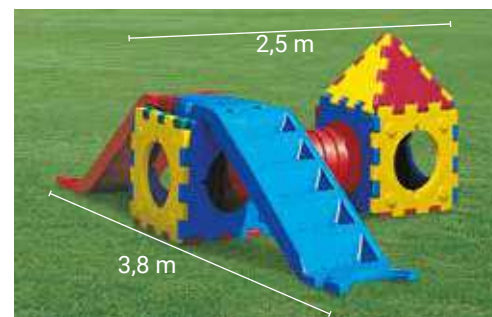

MODELLO F / MODEL F

art. 165

composto da / includes

11 pannelli / cube sides

1 tunnel / tunnel

2 scivoli-scala / step-slides

4 triangoli / triangles

1 tappo / top section



art. 148

CUBO SCALETTA / LADDER CUBE

composto da / includes

5 pannelli / cube sides

1 pannello scaletta / ladder side



art. 156

CASSETTA CUBIC TOY / CUBIC TOY HOUSE

composto da / includes

5 pannelli / cube sides

4 triangoli / triangles



art. 166

CASSETTA "FIVE" / "FIVE" HOUSE

composto da / includes

5 pannelli / cube sides

5 triangoli / triangles

CUBIC TOY - ACCESSORI PER SOSTITUZIONI *

CUBIC TOY - COMPONENTS *

Conforme / in compliance with
UNI EN 1176-1/3



art. 149
TRIANGOLO PER TETTO
TRIANGLE FOR ROOF
75x75x75 cm



art. 150
PANNELLO SCALETTA
LADDER SIDE
75x75 cm

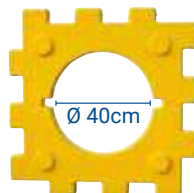

art. 151
PANNELLO FORO Ø 40 cm
CUBE SIDE Ø 40 cm HOLE
75x75 cm

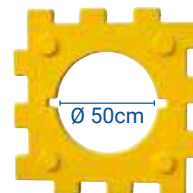

art. 308
PANNELLO FORO Ø 50 cm
CUBE SIDE Ø 50 cm HOLE
75x75 cm



art. 154
SUPPORTO
CONNECTOR
28x7 cm



art. 153
TAPPO
TOP SECTION
47x15 cm



art. 304
BALAUSTRÀ
PROTECTIVE SIDE
119x65 cm



art. 155
SCIVOLO - SCALA
STEP - SLIDE
130,6 cm



art. 305
SCIVOLO GRANDE
LARGE SLIDE

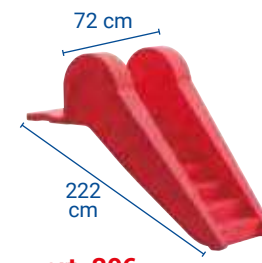

art. 306
SCALA GRANDE
LARGE STARWAY



art. 152
TUNNEL Ø 40 cm
TUNNEL Ø 40 cm
93 x Ø 40 cm



art. 168
TUNNEL Ø 50 cm
TUNNEL Ø 50 cm
120 x Ø 50 cm

* solo in caso di sostituzione e su prenotazione / *only in case of replacement and to be booked*



- 40 anni di esperienza
- 1.000 mq area produttiva
- 3.000 mq di uffici e magazzini

Tecnologie di stampaggio:
rotazionale, soffiaggio e Iniezione

Italveneta Didattica è sinonimo di:
prodotto italiano, flessibilità e disponibilità
immediata, sicurezza e qualità.



a better play



- 40 years of experience
- 1.000 sqm productive unit
- 3.000 sqm headquarters and warehouse

*Manufacturing technologies:
rotation, blow moulding and injection*

*Italveneta Didattica guarantees:
italian products, immediate product
availability, safety and quality.*



**italveneta
didattica**
a better play

www.italvenetadidattica.com

**italveneta
didattica**
a better play
www.italvenetadidattica.com

Italveneta Didattica srl

Via Risorgimento 32
30010 Pegolotte di Cona / Venezia / Italy

Tel. +39 0426 308348 / +39 0426 309147

Fax +39 0426 308347

info@italvenetadidattica.com



Distribuito da / *Distributed by*

www.italvenetadidattica.com